



Supplies and Accessories Catalogue | Issue 11 2024

# Providing High Quality ICP-OES & ICP-MS Sample Introduction Solutions for Over 40 Years.



## Nebulizers

Introduction to Glass Expansion Nebulizers .....	1
Nebulizer Types .....	1
Glass Expansion Nebulizer Part Numbers Explained .....	1
Learn about Glass Expansion Nebulizers .....	2
Nebulizer Selection Guide .....	5

## Spray Chambers

Introduction to Glass Expansion Spray Chambers .....	7
Spray Chamber Types .....	7
Helix CT - Interface Between Nebulizer and Spray Chamber .....	8
HydraMist Simultaneous Cold Vapor/Pneumatic Nebulization Spray Chamber .....	9
Spray Chamber Selection Guide .....	10

## Torches

## RF Coils

## ICP-MS Cones

## Accessories

IsoMist Programmable Temperature Spray Chambers .....	14
Guardian In-Line Sample Filter .....	15
Guardian In-Line Non-Return Gas Filter .....	15
Eluo Nebulizer Cleaning Tool .....	16
Elegra Argon Humidifier .....	16
High Efficiency Sample Introduction System for ICP-MS .....	17
Trident CT In-Line Reagent Additions Kit .....	18
Laser Ablation .....	19
Guardian Autosampler Probes .....	20
Autosampler Probes .....	21

## Agilent Technologies®

7900 .....	ICP-MS	22
8900 .....	ICP-MS	25
7800/7850 .....	ICP-MS	28
7700/8800 .....	ICP-MS	31
5000 Series SVDV/VDV/RV .....	ICP-OES	34

## Analytik Jena®

PlasmaQuant 9000 Series .....	ICP-OES	37
-------------------------------	---------	----

## Nu Instruments®

Vitesse .....	TOF-ICP-MS	39
---------------	------------	----

## PerkinElmer®

NexION 2200 .....	ICP-MS	40
NexION 5000 .....	ICP-MS	42
NexION 1000, 1100, 2000 .....	ICP-MS	44
NexION 300/350 .....	ICP-MS	46
Avio 200/500 Series .....	ICP-OES	49
Optima 8000/8300 DV .....	ICP-OES	51

## Shimadzu®

2040/2050 .....	ICP-MS	53
2030 .....	ICP-MS	55
9000/9800 and 7500/8100 .....	ICP-OES	58

## Spectro™

Arcos II EOP/ Blue EOP/TI & Green TI .....	ICP-OES	61
Arcos II SOP/ Blue SOP & Green SOP/DSOI .....	ICP-OES	64

## Thermo Fisher Scientific®

Q/RQ/TQ/RQ Plus .....	ICP-MS	66
Neoma .....	MC-ICP-MS	68
PRO Duo .....	ICP-OES	70
PRO Radial .....	ICP-OES	73
6000/7000 Duo .....	ICP-OES	76
6000/7000 Radial .....	ICP-OES	79

## Fittings and Connectors

Nebulizer Fittings and Connectors .....	81
Spray Chamber/Torches Fittings and Connectors .....	82

## Pump Tubing

Standard Peristaltic Pump Tubing .....	83
Contour Flared End Peristaltic Pump Tubing .....	86

**Note:** Clicking on the part numbers (PN) in this document will redirect you to our website for additional information.

## Introduction to Glass Expansion Nebulizers

The nebulizer is a critical component of your ICP sample introduction system, so why not opt for the highest quality? Glass Expansion has been manufacturing ICP nebulizers since the early 1980s and continually updates nebulizer designs to improve performance and ease of use. Our proprietary designs include a thick walled VitriCone capillary, UniFit sample line connector and the Direct Connect (DC) product line.

Whether your ICP laboratory is analyzing clean aqueous samples, samples containing HF and/or high dissolved salts, or volatile organic solvents; Glass Expansion has a nebulizer to suit your needs. Learn about the performance advantages and overall difference in construction quality that a Glass Expansion nebulizer can provide your ICP laboratory.

### Nebulizer Types

Nebulizer		TDS (%)	Particulates (µm)	HF	Precision	Purity	Material
SeaSpray™		20	75	No	High	Good	Glass
MicroMist™		15	40*	No	High	Good	Glass
Conikal™		5	75	No	High	Good	Glass
Slurry™		1	150	No	High	Good	Glass
Quartz SeaSpray™		20	75	No	High	Excellent	Quartz
OpalMist™		15	75*	Yes	High	Excellent	PFA
DuraMist™		30	75*	Yes	High	Good	PEEK
VeeSpray™		30	300	Yes	Moderate	Good	Ceramic

\* Varies with nebulizer uptake

### Understanding Nebulizer Part Numbers



Example: MicroMist DC Nebulizer  
0.2mL/min



Prefix denoting the type of gas connector to suit ICP model  
e.g. A13 = Agilent®

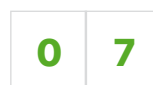

Argon flow in L/min  
e.g. 07 = 0.7L/min  
1 = 1L/min



Nebulizer model type  
e.g. UM = MicroMist U-Series

- UC = Conikal U-Series
- US = Slurry U-Series
- UM = MicroMist U-Series
- CV = Ceramic Veespray V-Groove
- DM = DuraMist HF Resistant
- USS = SeaSpray U-Series
- PFA = OpalMist PFA HF Resistant



Aspirated uptake at nominal argon flow, in mL/min  
e.g. 02 = 0.2mL/min  
1 = 1L/min

## Learn About Glass Expansion Nebulizers

### DC Nebulizers

The DC (Direct Connection) nebulizer has a UniFit sample connector which slides easily over the sample arm and an argon connector configured to connect directly to your ICP.

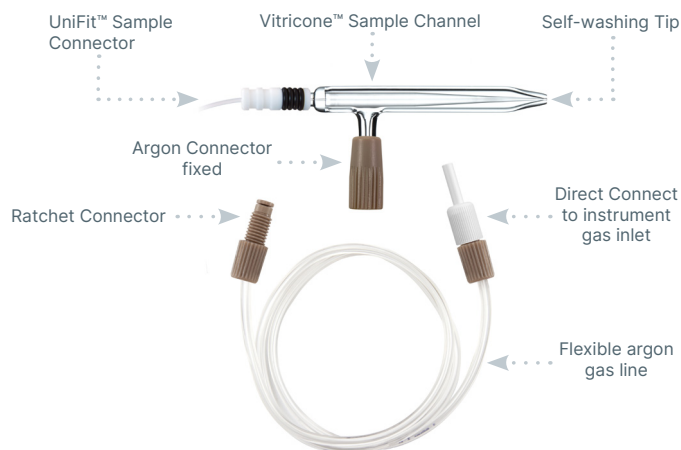

#### Benefits:

- Inert metal-free argon connector.
- Instrument-specific Direct Connect flexible argon line.
- Reliable ratchet fitting ensures leak-free gas connection.

DC versions of the SeaSpray, MicroMist, Conikal, Slurry, DuraMist, OpalMist and VeeSpray nebulizers are available to suit the most common models of ICP-OES and ICP-MS.

The DC nebulizer part number has a prefix specific to each type of gas connector. For example, the prefix "A13-" denotes a connector for the Agilent® 5000 ICP-OES Series, so part number A13-07-USS2 is a SeaSpray nebulizer configured for direct connection to the Agilent® 5000 Series.

#### In addition to these unique benefits, the DC nebulizer shares the following benefits with the U-Series nebulizer:

- **Resists blockage:** The sample channel is uniform from the entry point to the tip, so there is nowhere for particulates to be trapped.
- **Fast washout:** Since there is nowhere for sample to be trapped, the fastest possible washout and highest sample throughput is achieved.
- **Simple to use:** Our proprietary UniFit connector slides easily over the sample arm and creates an excellent seal.
- **Full length VitriCone construction:** With the VitriCone design, the sample channel is constructed from heavy glass capillary which is machined to very high tolerances.

### Quartz SeaSpray DC Nebulizer

The Quartz SeaSpray DC nebulizer is made from ultra pure quartz and offers outstanding nebulization efficiency for trace level analyses. It offers freedom from clogging while nebulizing solutions to the limit of solubility of most mineral salts, and conferring significant sensitivity gains. It is specifically designed for ultra trace level analysis.



## DC Nebulizer Gas Fitting Connectors

Manufacturer	Model	P/N Prefix	Gas Line Included	
Agilent Technologies®	4100/4200	MP11-	70-803-0969	
Agilent Technologies®	Vista/700-ES	A11-	70-803-0969	
Agilent Technologies®	7700/7800/7850/7900/8800/8900	A13-	70-803-1105	
Agilent Technologies®	5000 Series	A13-	70-803-1105	
Analytik Jena®	ICP-MS	A61-	70-803-2002	
Analytik Jena®	ICP-OES	A13-	70-803-1105	
Horiba® Jobin Yvon	All Models	A13-	70-803-1105	
Leeman	All Models	A11-	70-803-0969	
Nu Instruments	ICP-MS	A51-	70-803-1858	
Nu Instruments	TOF-ICP-MS	A52-	70-803-2044	
PerkinElmer®	ICP-OES	A21-	70-803-1070	
PerkinElmer®	Elan/NexION 300/350	A22-	70-803-1049	
PerkinElmer®	NexION 1000, 1100, 2000, 2200, 5000	A23-	70-803-1449	
Radom	MICAP® – OES™ 1000	A70-	70-803-2054	
Shimadzu®	All Models	A41-	70-803-1311	
Spectro™	All Models	A21-	70-803-1070	
Standard BioTools™ (Fluidigm)	Helios	A21-	70-803-1070	
Thermo Fisher Scientific®	PRO, 6000/7000, Q/RQ/TQ/RQ Plus, X-Series & Neoma	A31-	70-803-1105	
Thermo Fisher Scientific®	Neptune	A11-	70-803-0969	

## U-Series Glass Concentric Nebulizers

SeaSpray, MicroMist, Conikal and Slurry U-Series nebulizers are available to suit all common models of ICP-OES and ICP-MS. Each U-Series nebulizer is supplied with a UniFit sample connector.

U-Series nebulizers can be identified by the letter 'U' in the part number, eg. ARG-07-USS2 or ARG-1-UM04.

The difference between the U series nebulizer and DC nebulizers lies solely in the argon gas connector. The U series nebulizer features the EzyLok argon connector, while DC nebulizers utilize advanced direct connect (DC) argon fittings. The inert, metal-free DC argon gas fittings and Ratchet Connector ensure reliable, reproducible, and leak-free connections, keeping analyses contaminant-free.



## Nexus™ Universal Nebulizer Connection Kit

The Nexus™ Universal Connection Kit is a one-size-fits-all nebulizer connection kit which enables you to use any of Glass Expansion's industry-leading concentric nebulizers\* with the sample introduction configuration of your choice, including switching valves, chromatographs (LC, HPLC, IC, etc.), and other high-performance accessories:

- **Switching Valves:** Simple and reliable custom-length connections to all high-throughput valve or syringe-drive systems.
- **Speciation Analysis:** Zero-dead-volume and secure, high-pressure connection for hyphenated techniques, such as LC-ICP-MS, HPLC-ICP-MS, IC-ICP-MS, and FFF-ICP-MS.
- **High-Efficiency Sample Introduction System (HE-SIS):** Connect to Glass Expansion's HE-SIS, which provides up to 95% transport efficiency for a variety of applications.
- **High-Precision Analysis:** Create a high-pressure seal when performing self-aspiration for the most stable sample uptake and delivery.

These easy-to-install kits are completely inert and configured for 1.6 mm (1/16") OD tubing, with PTFE ferrules that reliably seal with all commonly used capillary tubing materials, such as PFA, PTFE, FEP and PEEK. They provide a secure, zero-dead-volume direct connection to the liquid interface of a Glass Expansion nebulizer.

### Nexus™ Universal Nebulizer Connection Kits

Nexus™ Universal Connection Kit for all Glass Concentric U-Series or DC nebulizers	FT-16-8
Nexus™ Universal Connection Kit for Inert nebulizers	FT-16-8-X
Nebulizer Sample Connecting Line Kit (0.18mm ID x 220mm)	70-803-2112
Connector Tube with 1/4-28 fitting 0.25mm ID x 700mm (PKT. 3)	70-803-1870
Connector Tube with 1/4-28 fitting 0.50mm ID x 700mm (PKT. 3)	70-803-1871
Replacement Flangeless Tefzel Ferrule 1.6mm for FT-16-8 and FT-16-8-X (PKT 10)	70-803-1315
Replacement Flangeless Tefzel Ferrule 1/8 inch for FT-16-8 (PKT 10)	70-803-1316
Replacement Flangeless Tefzel Ferrule 1/8 inch for FT-16-8-X (PKT 10)	70-803-1513

### P/N FT-16-8

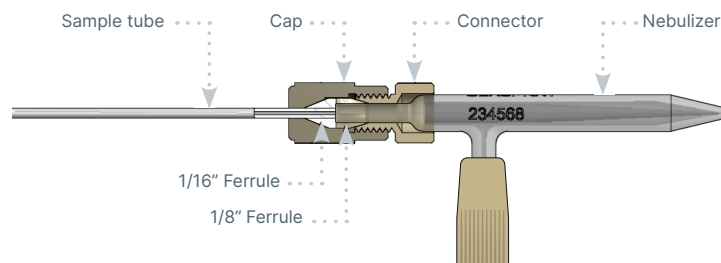

### P/N FT-16-8-X

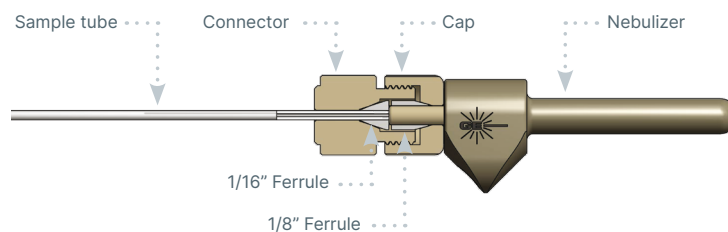

\*The Nexus™ Universal Connection Kit is designed for U-Series (ARG) and DC (A##) nebulizers. It is not compatible with the older EzyFit (AR##) nebulizers.

## Nebulizer Selection Guide

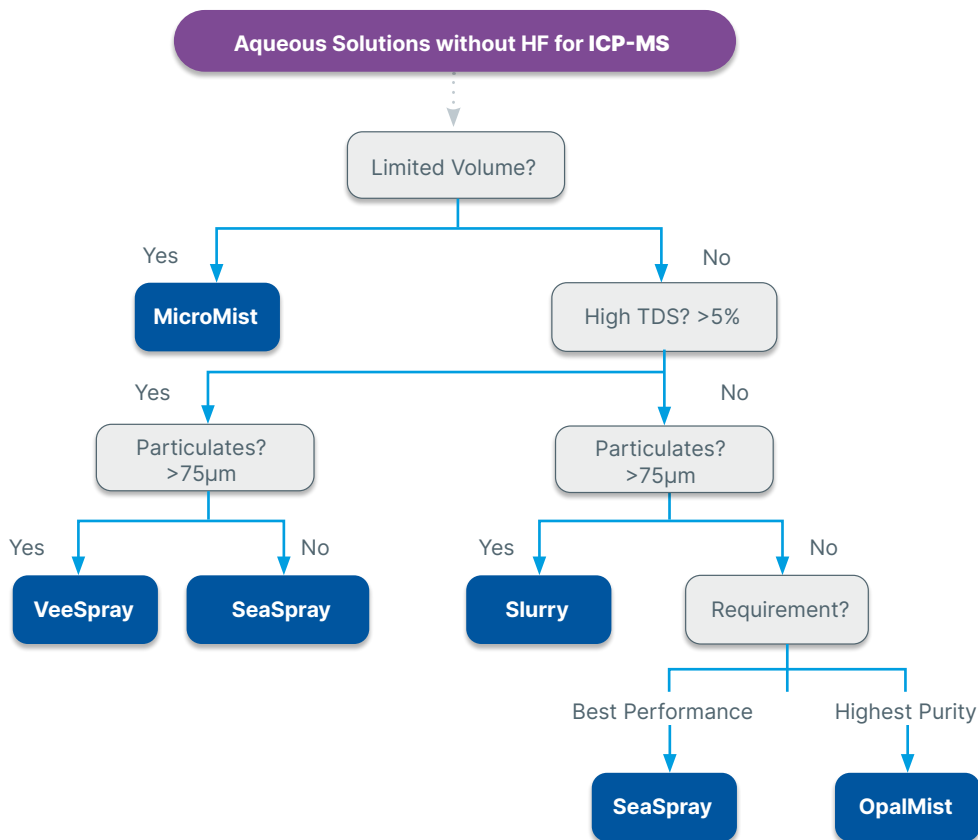
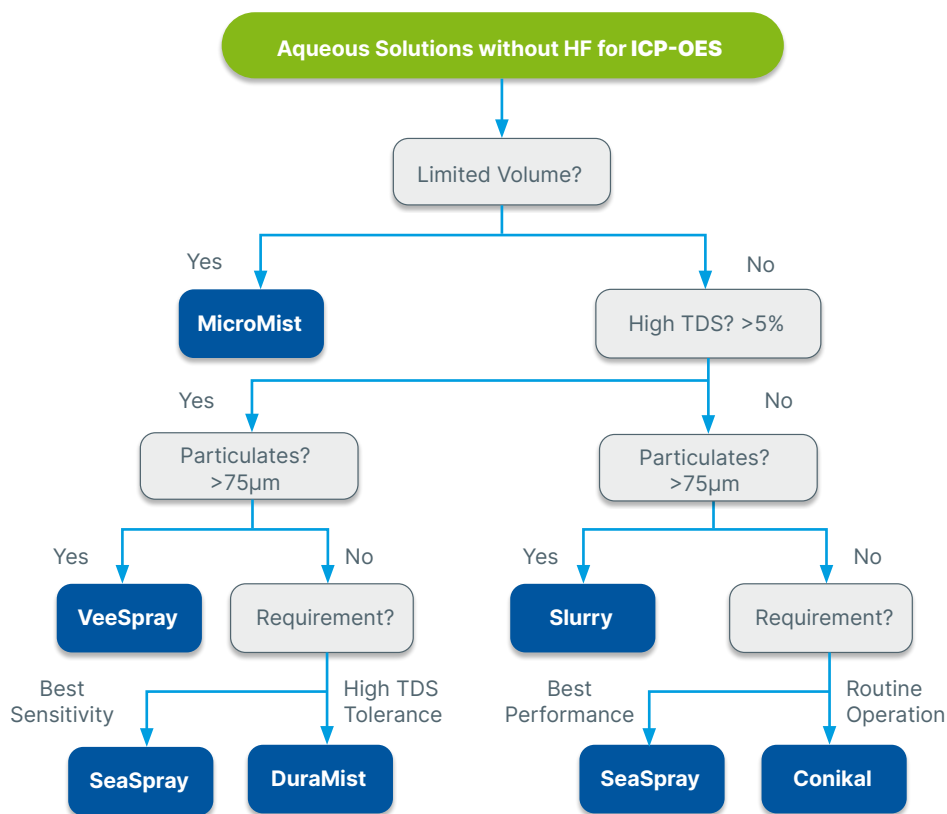

## Nebulizer Selection Guide

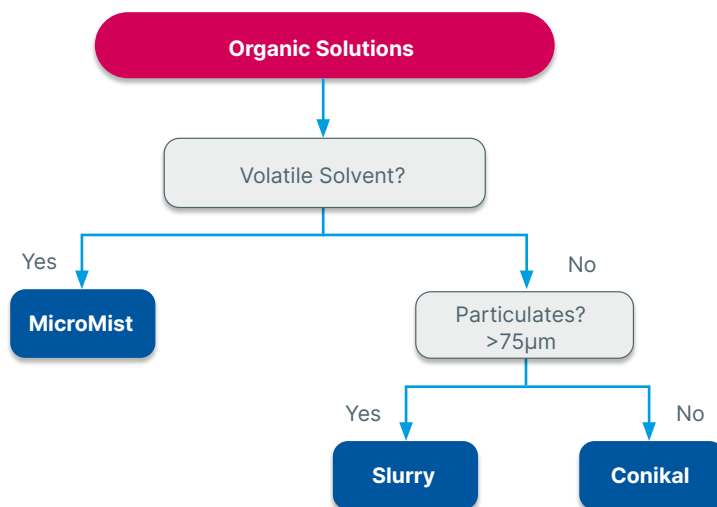
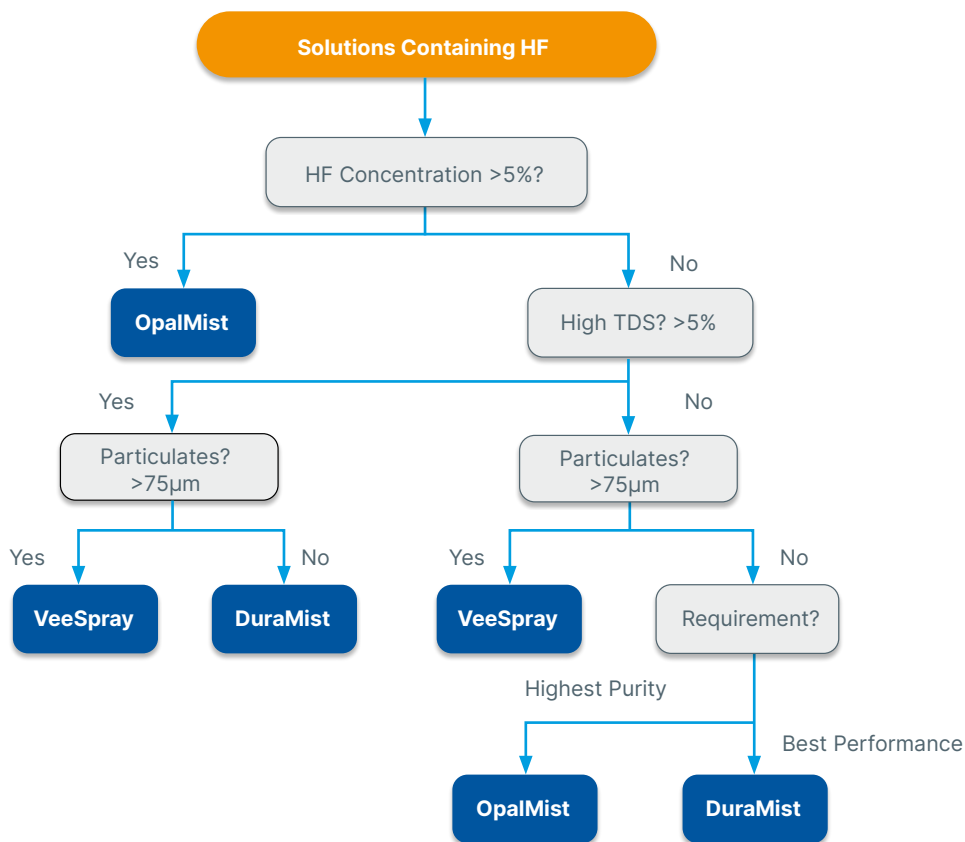



## Introduction to Glass Expansion Spray Chambers

The spray chamber is a crucial component of the ICP sample introduction system since it has a profound effect on transport efficiency, precision, and washout. Glass Expansion revolutionized the spray chamber design for the ICP industry with the Tracey and Twister cyclonic spray chamber, providing improved efficiency and reduced washout. Glass Expansion's unique Helix CT nebulizer interface, provides a zero dead volume seal that results in higher throughput compared to non-Glass Expansion designs.

### Spray Chamber Types

DC Tracey™



Internal Volume, mL: 30  
 Internal Baffle: No  
 HF-resistant: No  
 Precision: Very Good  
 Purity: Good  
 Material: Glass

Twinnabar™



Internal Volume, mL: 20  
 Internal Baffle: Yes  
 HF-resistant: No  
 Precision: Very Good  
 Purity: Good  
 Material: Glass

Tracey™



Internal Volume, mL: 50  
 Internal Baffle: No  
 HF-resistant: No  
 Precision: Very Good  
 Purity: Good  
 Material: Glass

Tracey™ TFE



Internal Volume, mL: 50  
 Internal Baffle: No  
 HF-resistant: Yes  
 Precision: Good  
 Purity: Good  
 Material: PTFE

Twister™



Internal Volume, mL: 50  
 Internal Baffle: Yes  
 HF-resistant: No  
 Precision: Excellent  
 Purity: Good  
 Material: Glass

Twister™ TFE



Internal Volume, mL: 50  
 Internal Baffle: Yes  
 HF-resistant: Yes  
 Precision: Very Good  
 Purity: Good  
 Material: PTFE

Cinnabar™



Internal Volume, mL: 20  
 Internal Baffle: No  
 HF-resistant: No  
 Precision: Very Good  
 Purity: Good  
 Material: Glass

Tracey™ PFA44



Internal Volume, mL: 44  
 Internal Baffle: No  
 HF-resistant: Yes  
 Precision: Good  
 Purity: Excellent  
 Material: PFA

## Helix CT™ - The Modern Interface Between Nebulizer and Spray Chamber

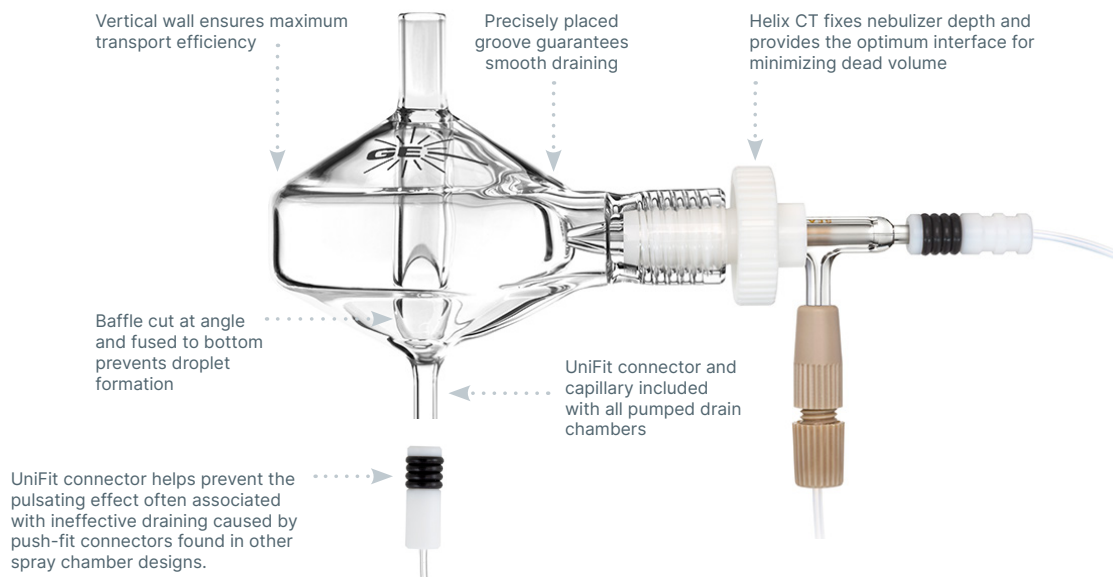

Traditionally, ICP-OES and ICP-MS sample introduction systems have relied on o-rings to form a gas-tight seal between the nebulizer and spray chamber. There are several drawbacks with an o-ring seal, such as:

- Potential for contamination due to dead volume around the o-ring seal.
- Chemical resistivity of strong acids and organic solvents.
- Even the most chemically resistant O-rings are prone to wear and tear and require regular replacement, which is time-consuming and often requires the use of tools.
- Bonding to the nebulizer can result in breakage.

Glass Expansion Helix CT spray chamber with ConstantTorque™ technology, provides a constant, reproducible, inert, gas-tight seal between the nebulizer and spray chamber.

The main feature of the Helix CT spray chamber is the **Helix locking screw with built-in torque control mechanism** that allows for a consistent seal of the PTFE ferrule against the nebulizer –making it impossible to overtighten or undertighten while ensuring a gas-tight seal each and every time.

A PressFit PTFE ferrule provides a chemically inert seal around the nebulizer, which is immune to strong acids and organic solvents routinely used in ICP sample preparation.

The Helix CT cyclonic spray chamber by Glass Expansion, therefore, eliminates all the drawbacks of the o-ring nebulizer seal, while improving user safety by preventing broken nebulizers.

Helix CT nebulizer interface is also simple to use:

- Fully insert the nebulizer into the Helix CT interface, until the nebulizer side-arm comes into contact with the molded-in positive stop.
- Hand-tighten the Helix CT locking screw until the ConstantTorque mechanism clicks, indicating a secure, gas-tight seal.

Glass Expansion equips all of its cyclonic spray chambers with the Helix CT interface as standard.

Part Number	Description
70-803-1439	Helix CT Locking Screw with Seal
70-803-1456	Helix CT Seal (PKT. 4)



## HydraMist™ Simultaneous Cold Vapor/Pneumatic Nebulization Spray Chamber

The Glass Expansion HydraMist is a sensitive, simple-to-use spray chamber for Inductively Coupled Plasma (ICP) that allows simultaneous operation of both conventional pneumatic nebulization and cold-vapor/hydride generation. Cold vapor generation can provide more than 10-fold improvement in sensitivity on ICP for cold vapor forming elements such as As, Sb, Se, and Hg. The generation of volatile species of these elements results in increased analyte loading of the analytical plasma giving lower detection limits.

The design of the HydraMist spray chamber is based upon Glass Expansion's industry-standard cyclonic spray chamber, giving excellent sensitivity and short-term analytical precision with fast washout. The HydraMist spray chamber features a secondary inlet port that mixes the aerosolized sample and liquid reductant inside the spray chamber for rapid conversion of the As, Sb, Se, and Hg analytes into volatile hydride species. The unique drain design ensures fast, complete removal of waste from the spray chamber, eliminating excess hydrogen build-up that causes sample reflux degrading analytical precision.

### The HydraMist Spray Chamber Features:

- The same outstanding short-term analytical precision and washout as other Glass Expansion cyclonic spray chambers
- Fast and complete vapor phase formation of volatile As, Se, Sb, and Hg species for the best detection limits in hydride generation mode
- A unique drain design to eliminate hydrogen build-up and sample reflux that degrades short-term precision
- Economic, just replace your current spray chamber and keep your existing nebulizer
- Improve productivity by analysing non-hydride forming elements and cold vapor elements simultaneously, avoiding system shutdowns to change over between the hydride generator accessory and conventional pneumatic nebulization

#### HydraMist Kit

Agilent® 5000 ICP-OES Series	KT-1157
Analytik Jena® PQ 9000	KT-1157
PerkinElmer® Avio 200/500	KT-1157
PerkinElmer® Avio with HTS system	KT-2742
PerkinElmer® Optima 8000/8300 DV	KT-1162
PerkinElmer® Optima 4000/5000/7000 DV	KT-1162
Shimadzu® ICPE 9000/9800	KT-1157
Spectro™ Arcos II SOP/EOP and Blue EOP/SOP	KT-1160
Thermo® PRO	KT-1160
Thermo® Duo 7600	KT-1156
Thermo® Duo 6000/7200/7400	KT-1179

\* Note: Nebulizer is not included in HydraMist Kit.

#### Simple Mode

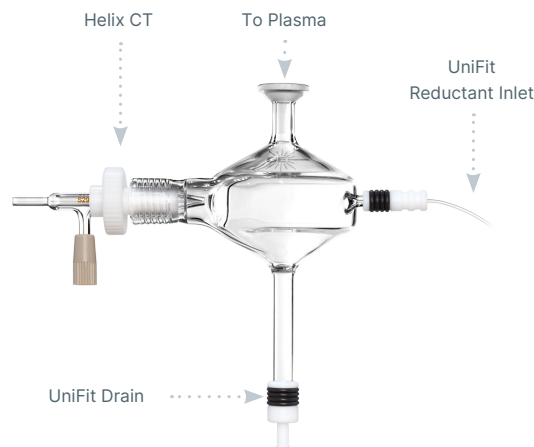

#### Sensitive Mode

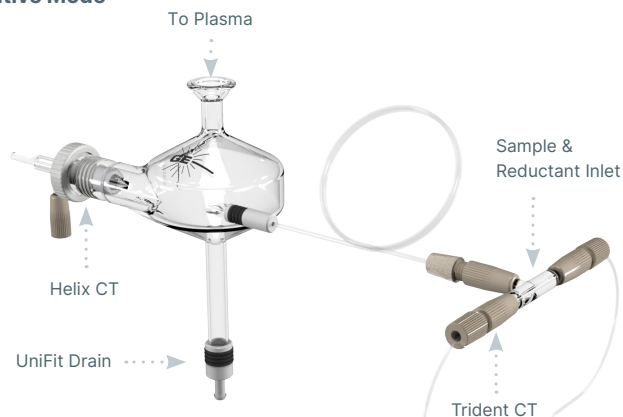

#### Pneumatic Nebulization

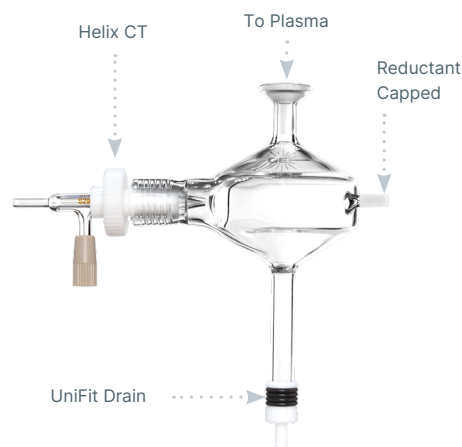

## Spray Chamber Selection Guide

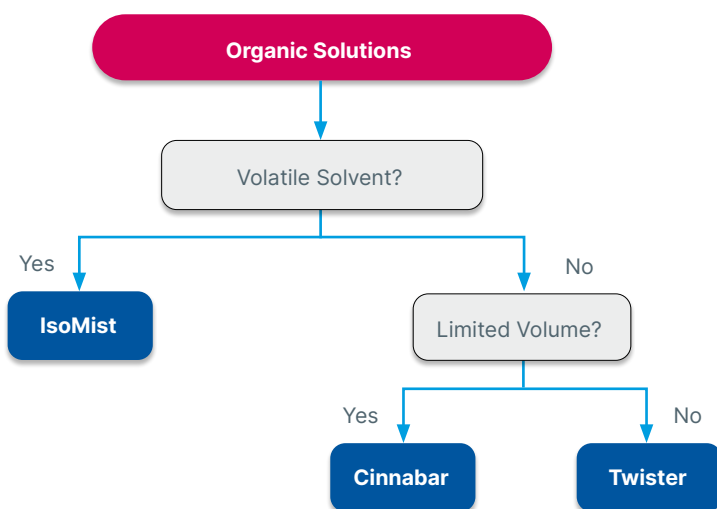
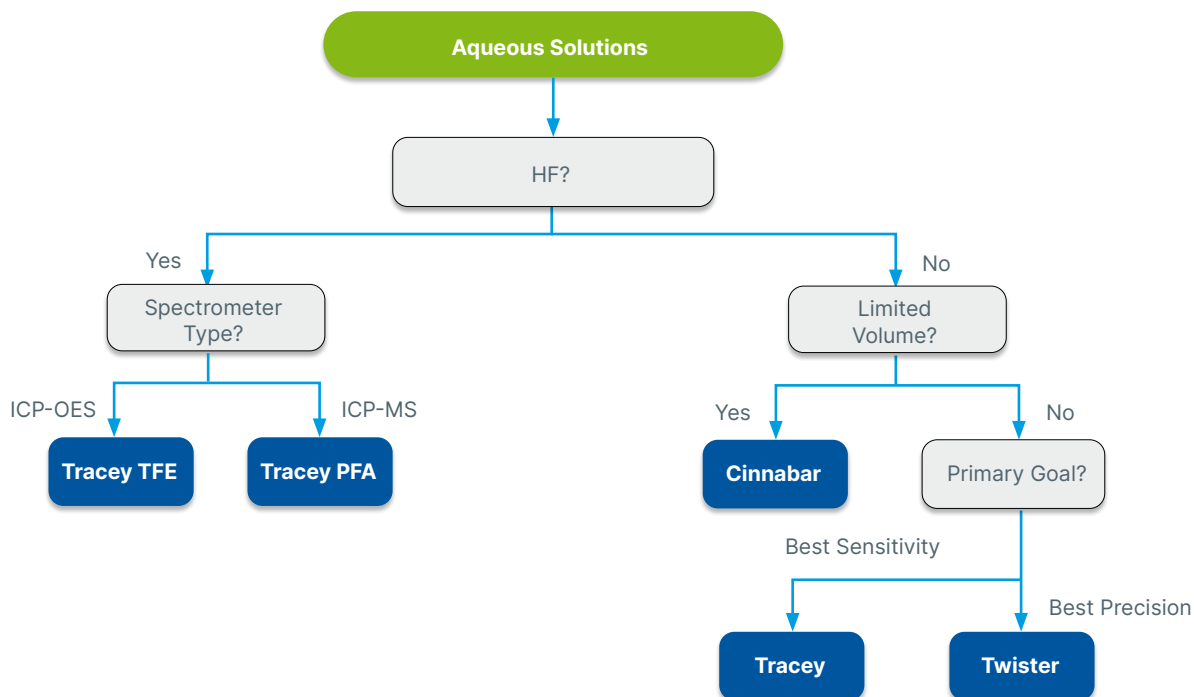

## D-Torch™ (Demountable Torch)

The D-Torch is a revolutionary demountable torch design. It provides the benefits of a fully demountable torch at a significantly lower cost. Interchangeable outer tubes made of quartz or ceramic are available. The quartz tube is ideal for most aqueous applications and, since the outer tube is usually the first to wear, you can make a significant saving by replacing just the outer tube rather than the whole torch.

The ceramic outer tube is of particular benefit for the analysis of samples with high salt content or wear metals in engine oils, where quartz outer tubes often suffer from short lifetime. The ceramic outer tube has a much longer lifetime, greatly reducing interruptions and downtime due to torch failure. The D-Torch uses the same mounting system as the standard fixed torch so there is no additional cost or complexity to install it.

- Demountable outer tube – why replace the entire torch when just the outer tube wears?
- Interchangeable quartz and ceramic outer tubes.
- Much lower cost than other demountable torches.
- Interchangeable injectors for aqueous, organics, high dissolved solids or HF applications.

\* The D-Torch is covered by US Patent 8,232,500 B2

The D-Torch models suited for the Agilent® 5000 Series, PerkinElmer® Avio 200/500, Thermo® PRO and Spectro™ Arcos II and Blue incorporates the same easy to use, self-aligning and locking features of the standard torch in a robust cost effective design.

### Complete D-Torch



### Injectors



### Outer Tubes



### Torch Body



## Semi Demountable Torch



- Highly accurate construction
- Lower running cost than one-piece torches

Usually comprises a quartz torch body, a torch adaptor, an injector and GazFit connectors. All these parts are replaceable, making the semi demountable torch more cost effective than the fixed quartz torch. The design of the torch for standard analyses and HF analyses is the same, with only the injector material changing. For aqueous and organics analyses use a quartz injector, while for HF analyses use an alumina injector. Hence simply interchange between quartz and alumina injectors for appropriate analyses. Several internal diameters for both quartz and alumina injectors are also available.

## Fixed Quartz Torches (One Piece)



- Precise quartz construction
- Wide range held in stock
- Simple to use
- Lowest initial cost

## RF Coils – more efficient energy transfer

Glass Expansion Coils are produced from the highest quality raw materials and plated using prescribed methods to obtain maximum RF (Radio Frequency) transmission efficiency. There are numerous papers published on RF transmission with regard to conductor and coating resistance.

The torch box environment is highly corrosive, causing bare copper to corrode quickly and accumulate buildup, reducing coil conductivity and increasing resistance. Copper is used as the base material of all commercially available coils but different manufactures use different plating materials. Silver has the best conductance and gold the best corrosion resistance. Many platers use brighteners for a shiny finish, but high-purity silver and gold result in a dull appearance. Glass Expansion uses high-purity metals and polishes coils after plating for smoothness and reduced resistance, also enhancing visual appeal.

### Why Change your RF Coil?

- Regular replacement of corroded coils reduces the load on the RF generating system.
- Changing corroded coils increases energy transfer, resulting in a more robust plasma and generally higher analytical line intensities.

### Advantages of Glass Expansion RF Coils

- High quality and consistent plating of our coils promotes extended coil life.
- Each coil is supplied on a plastic former ensuring correct dimensions and easier installation.
- Each coil is supplied in a special protective container to ensure correct dimensions are maintained, and the coil arrives corrosion free.
- Optimal alignment of the RF coil mitigates outer tube devitrification.



## Glass Expansion Installation Kits for RF Coils

- Incorrect alignment of the torch in the coil will dramatically reduce torch life. The Glass Expansion Installation Kits help ensure correct alignment and maximum torch life.
- Correct alignment of the RF Coil with respect to the torch body reduces devitrification of the outer tube.
- Re-usable alignment tools are available separately to ensure correct installation of the coil every time.
- Our easy to follow Do-It-Yourself installation instructions save you time, and the cost of a service call.

### All kits contain:

- An Installation Kit – Aligns coil to torch mounting bracket.
- Required Spanner/s – Designed specifically for each instrument.
- Do-It-Yourself instructions.



## ICP-MS Cones



Our ICP-MS interface cones are made from ultra-pure metals sourced from specialty smelters. Our highly experienced machinists use state-of-the-art CNC machines and electron beam welding, which offer precise control, deep penetration, and minimal heat-affected zones compared to other welding techniques, to provide cones with the finest tolerances for the highest quality.

We supply cones for all of the popular ICP-MS models and, to make sure you get all the support you need, we have a staff of technical experts and a fully equipped ICP-MS laboratory for testing and evaluation.

### Satisfaction guarantee:

We guarantee our products to meet or exceed performance expectations.

### Refurbishment:

Extend the life of your platinum cones with our refurbishment program. In many cases, a platinum cone can be refurbished multiple times and its lifetime greatly extended.

### Platinum reclaim:

If your platinum cone cannot be refurbished, we will provide a rebate for the value of platinum in the cone.

### ConeGuard

The ConeGuard Thread Protector protects the cone thread from corrosive cleaning solutions and greatly extends cone life.

## ICP-MS Cone Resource Guide

Our ICP-MS Cone Resource Guide answers all the questions you ever had about cones. It includes the “why” and “how” of selecting the right cones, details on the advantages of different cone materials, and tips on care and maintenance.

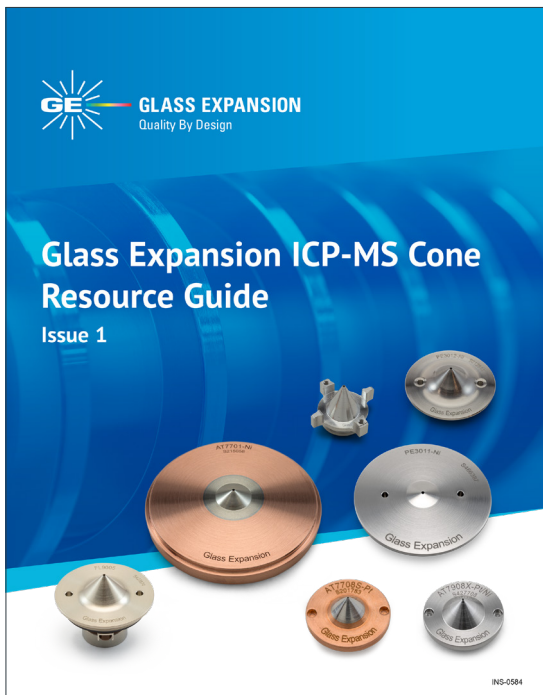

### Includes:

- About Glass Expansion ICP-MS Cones
- Platinum Cone Refurbishing
- Cone Material Guidelines
- Cones by ICP Model
- Cone Conditioning, Gasket & O-ring replacement guidelines
- Cone Maintenance

[Click here](#) to view the ICP-MS Cone Resource Guide.

### IsoMist™ Programmable Temperature Spray Chamber



The IsoMist programmable temperature controlled cyclonic spray chamber now features an improved thermodynamic design providing an extended temperature range and faster cool-down, so your ICP is ready to go sooner.

The IsoMist is a compact, convenient and maintenance-free temperature controlled sample introduction system for all ICP's.

#### Improved Analytical Stability with Precise Temperature Control

On the IsoMist, the spray chamber temperature is accurately controlled through an improved thermodynamic design using a multi-stage peltier device. The spray chamber temperature is settable in 1°C increments from -25°C to 80°C guaranteeing optimum conditions can be used for any application.

#### Reduce Oxide Interferences in ICP-MS

Using the IsoMist spray chamber at sub-ambient temperatures on an ICP-MS, the sample is cooled, less water vapor is transferred to the plasma resulting in lower oxide formation and reduced polyatomic (ArO, ArOH) interferences. Less oxides in the plasma mean fewer interferences, improving accuracy and detection limits.

#### Perfect for Naphtha and Gasoline Analysis

For volatile solvents, a lower sample introduction temperature reduces nebulization efficiency avoiding quenching of the plasma from solvent over-loading. With a minimum operating temperature of -25°C, analyzing volatile organic solvents such as naphtha and gasoline by ICP is even easier.

#### Improve Analytical Stability with Constant Spray Chamber Temperature

Fluctuations in the lab temperature affects sample viscosity and nebulization efficiency. Maintaining the sample introduction system at a constant and stable temperature improves analytical reproducibility, enhances throughput and lowers operating costs by reducing the need to re-run samples when a check standard drifts outside the acceptable upper or lower limits.

#### Elevated Sample Introduction Temperatures Enhances Sensitivity

The sensitivity for many analyses can be enhanced by operating the spray chamber at elevated temperatures - especially important for limited sample volumes. Heating the spray chamber also helps with the analysis of viscous samples such as lubricants and edible oils.

#### A Spray Chamber Optimized for Analytical Performance

The IsoMist incorporates a proven cyclonic spray chamber design in glass, quartz and HF resistant PFA with Helix CT interface. Compared to a Scott type spray chamber, cyclonic spray chambers are more sensitive and have better washout. The IsoMist includes the Helix CT nebulizer interface, which eliminates sample contamination and ensures easy nebulizer removal for routine nebulizer cleaning. The Helix CT nebulizer interface also has zero dead volume, reducing carry-over and improving washout between samples. With a positive stop built-in, Helix CT ensures correct and reproducible nebulizer insertion depth for constant nebulizer performance.



#### Easy to Use Software

For maximum convenience, the IsoMist can be controlled from a PC via USB or Bluetooth wireless interface. The spray chamber temperature can be monitored during an analytical run with time vs temperature plot on your PC screen.

#### Elegant, Ergonomic and Compact

The IsoMist is an elegant, compact, stand-alone system manufactured from materials resistant to attack from acids and solvents commonly used in ICP analysis. By using a peltier to maintain the spray chamber temperature, the messy, noisy and high-maintenance refrigerated circulating baths used with jacketed spray chambers has been eliminated. The compact design means all IsoMist Programmable Temperature Controlled Spray Chambers are compatible with virtually any ICP-OES or ICP-MS.



## Guardian™ In-Line Sample Filter



If there are particulates in your samples, there is a risk that they may get trapped in the narrow bore sample tubing or within the nebulizer. The Guardian In-Line Sample Filter provides a simple and effective way to eliminate this risk. This filter is easily inserted in the sample tubing between the autosampler probe and the nebulizer. It incorporates a 120 micron PolyComb filter and is suitable for use with 1/16 inch (1.6mm) OD or 1.3mm OD sample tubing.

The purpose-built clog-resistant design is ideal for ICP samples. Unlike sintered or frit style filters, the linear honeycomb structure makes the PolyComb filter resistant to clogging from particulates. Any particle build-up is easily removed by back-flushing using the Eluo Adaptor 70-803-1160. And the PEEK material is suitable for use with all of the most common ICP solutions.



Eluo Adapter For In-Line Filter

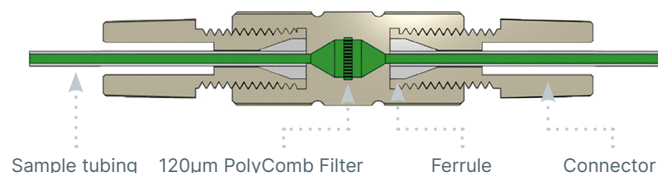

### Guardian In-Line Sample Filter

In-Line Filter	70-803-1108
Eluo Adaptor for In-Line Filter	70-803-1160
Replacement Viton O-rings for Eluo Adaptor (PKT 10)	70-V-009
Fitting Seal 1/16 (PKT 10)	70-803-0749
Fitting Seal 1.3mm (PKT 10)	70-803-0748
Ratchet Connector	70-803-1350

## Guardian™ In-Line Non-Return Gas Filter



The new Guardian In-line Non-Return Gas Filter provides protection for your ICP system in two ways:

1. A non-return valve prevents acidified sample or rinse solution syphoning into the instrument gas box.
2. 30µm PolyComb filter protects the nebulizer from particulates in the instrument gas supply.

The Guardian In-line Non-Return Gas Filter is positioned between the Argon inlet on the Direct Connection nebulizer and the gas supply fitting on the instrument. The In-line Non-Return Filter has a one-way valve that allows argon to flow from the instrument into the nebulizer, but prevents liquid syphoning into the instrument. A unique PolyComb 30µm filter design protects the nebulizer from particulates from the gas supply or from worn or damaged fittings in the gas lines. Unlike Sintered or Frit style filters, the linear honeycomb structure makes PolyComb most resistant to particulate and dissolved solid clogging.

Syphoning of the sample or rinse solution into the nebulizer argon control module on your ICP can occur at the end of an analytical run when the nebulizer gas pressure is turned off and there is liquid in the sample flow path. It is made worse if the autosampler probe stays in the rinse position at the end of a run.

An overlooked issue when using an autosampler for unattended overnight runs is its potential to silently and invisibly damage your ICP instrument. Acidified solution in the instrument's argon control module can corrode electronic sensors in mass flow controllers and damage regulators, leading to costly repairs and unplanned downtime.

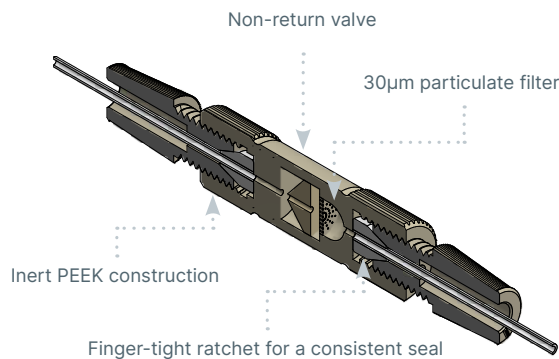

### Guardian In-Line Non-Return Gas Filter

Guardian DC In-Line Non-Return Gas Filter	70-803-1942
Guardian In-Line Non-Return Gas Filter	70-803-1362

\*Choose P/N 70-803-1942 if using a DC nebulizer model.

## Eluo™ Nebulizer Cleaning Tool

As easy as 1, 2, 3

### 1. Fill with solvent



### 2. Insert nebulizer



### 3. Clean nebulizer



Particle build-up in a nebulizer capillary and tip causes sample flow to be constricted, reducing nebulizer efficiency and performance. Now, blocked nebulizers can be safely and easily restored to optimum performance with a revolutionary cleaning instrument – the Eluo.

The Eluo is designed to efficiently deliver a cleanser through the nebulizer capillary to dislodge particle build-up and thoroughly clean the nebulizer. One simple action does it all. No more messy procedures or shattered nebulizers in ultrasonic baths. Use the Eluo regularly to maintain nebulizer performance and prolong nebulizer life. Every lab should have an Eluo.

The Eluo can also be conveniently used to clean the Inline Particle Filter P/N 70-803-1108 with the addition of Adaptor P/N 70-803-1160.

We have found that using a dilute concentration of Fluka RBS-25 (manufactured by Sigma-Aldrich, and is available from most suppliers of laboratory chemicals ) is the best cleaning solution. Stubborn clogs may require an overnight soak or additional cleaning with nitric acid.

### Eluo Nebulizer Cleaning Tool

Eluo for Glass concentric Nebulizers	70-ELUO
Eluo HF for OpalMist or DuraMist	70-ELUO-OPD
Eluo Barrel	703-0058
Eluo Plunger	70-703-0070
Eluo HF Nebulizer Holder	70-803-0932
Eluo Nebulizer Holder for Glass concentric Nebulizers	70-703-0069
Eluo Adaptor for Inline Filter	70-803-1160
O-ring Kit for Eluo (2 sets)	70-0806

## Elegra™ Argon Humidifier

To Spectrometer gas port .....  
 To Nebulizer .....  
 Gas Inlet .....  
 Gas Outlet .....



An Argon Humidifier is commonly used in ICP analyses involving samples with high concentrations of dissolved solids. It helps to alleviate salt deposits in the nebulizer and torch injector, allowing uninterrupted and maintenance-free operation.

- Compact, cost-effective design.
- No heating or electric power required.
- Non-pressurized water reservoir.
- An easy-to-use bypass switch allows you to take the Elegra off-line without disconnecting argon lines. (Not available with Elegra Dual)
- Highly efficient membrane humidification technology.
- Improved signal stability for samples with high TDS.
- Simple to install, use and maintain.
- Improves productivity by reducing down-time for cleaning.
- Inert metal-free construction eliminates contamination.
- Maximum and minimum fill marks ensure that you are always operating under optimum conditions.
- Compatible with all ICP-OES and ICP-MS models. Direct connection to argon outlet provided for most models.
- Elegra Dual configuration available for ICP-MS instruments using auxiliary argon.

### Elegra Argon Humidifier

O-ring for Capricorn or Elegra Cap (PKT 3)	70-V-225
Elegra Stand	70-803-1581
Elegra Membrane	70-803-1286
Elegra Reservoir	70-803-1257

[Click here](#) to view the Elegra™ Landing page and ordering information.

## High Efficiency Sample Introduction System (HE-SIS)

Originally designed as a highly efficient single-cell sample introduction system, Glass Expansion's HE-SIS has been redesigned to provide superior performance across a wide variety of applications, including single-cell, single particle, nanoparticle, and low-volume sample studies, with up to 95% transport efficiency.

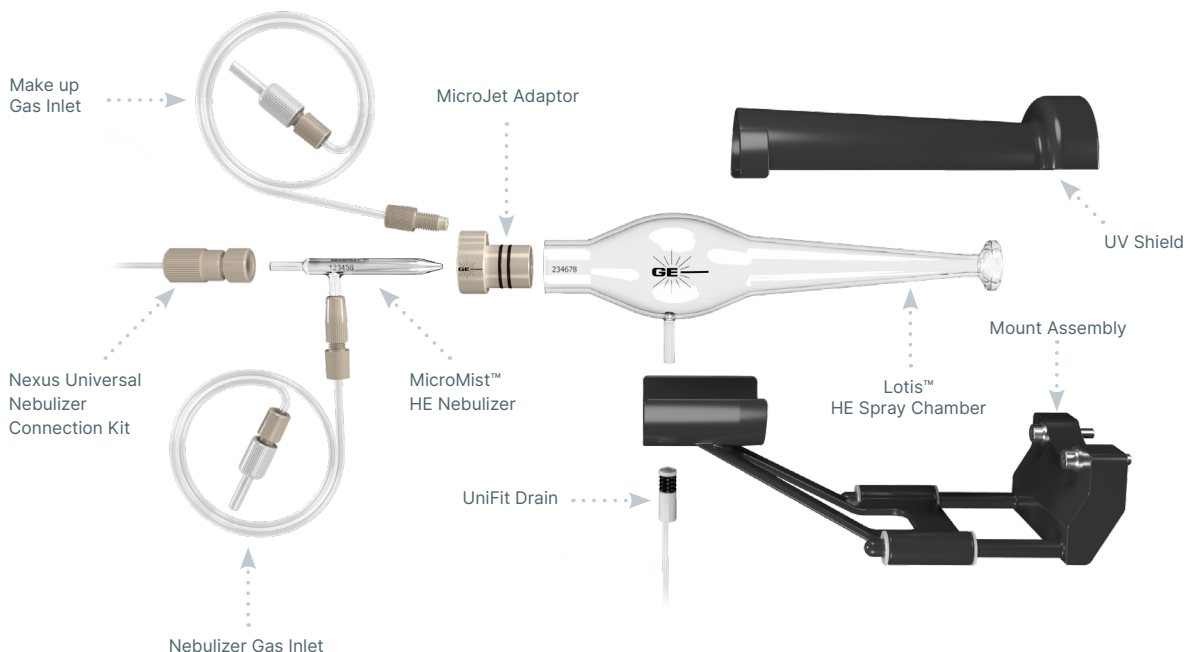

### Key HE-SIS Components

#### MicroMist™ High Efficiency (HE) Nebulizer

This specially designed concentric glass nebulizer is based on our popular MicroMist design, capable of efficiently nebulizing limited sample volumes at low sample and argon gas flow rates.



#### Patent-pending MicroJet™ Gas Adaptor

Our patent-pending MicroJet gas adaptor shapes the nebulizer aerosol plume to reduce sample deposition on the spray chamber walls and enhance transport efficiency.

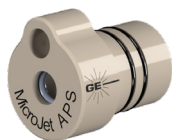

#### Lotis™ High Efficiency (HE) Spray Chamber

The Lotis HE spray chamber directly couples to the ICP-MS torch, providing the highest transport efficiency and excellent washout between samples.



### High Efficiency Sample Introduction System

For Agilent® ICP-MS	KT-1155
For Thermo® Q/RQ/TQ ICP-MS	KT-1172
For Thermo® Neoma MC-ICP-MS	KT-1172
For TOFWERK icpTOF	KT-1172
For PerkinElmer® NexION 1000/2000/2200/5000	KT-1184
For PerkinElmer® NexION 300/350	KT-1204
For Nu ATTOM	KT-1205
For Thermo® X Series	KT-1213
For Thermo® Neptune/Element	KT-1215
For Nu Instruments® Vitesse TOF-ICP-MS	KT-1219

## Trident CT™ In-Line Reagent Additions Kits

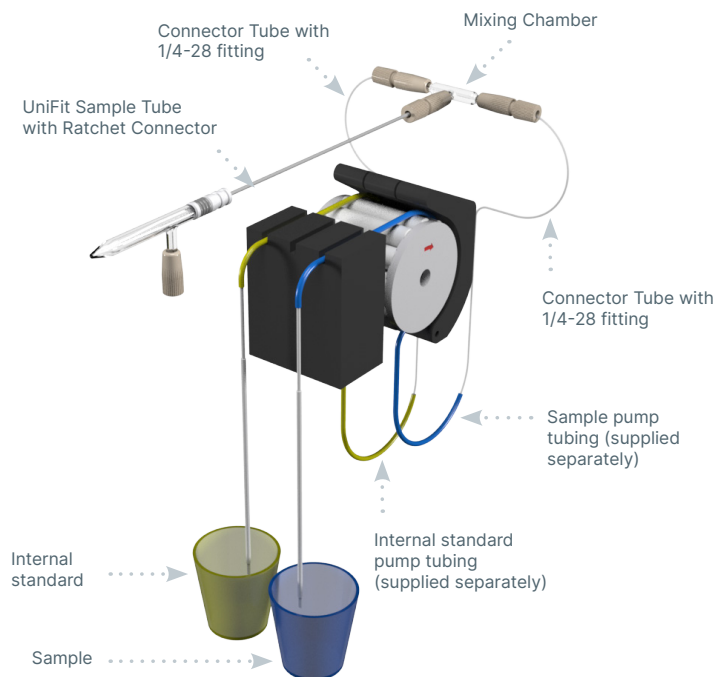

Internal standards are often used in ICP Spectrometry to improve stability. The internal standardization process involves the addition of a known concentration of a particular element to every sample and can be a very time-consuming procedure. The Glass Expansion Trident Kits allow the internal standard to be automatically mixed with each sample during sample introduction, saving considerable sample preparation time.

The Trident CT mixing chamber is based on the industry-proven design of the Trident, but with the addition of Glass Expansion's ConstantTorque (CT) to provide a simple-to-use, leak-free connection for both the internal standard and sample, every time.

The heart of the kit is the mixing chamber, designed with zero dead volume CT fittings. With other mixing chambers, worn or improperly fitted connections leak, inject a stream of air bubbles into the nebulizer flow, degrading short-term analytical precision (%RSD). By using CT ratchet-style fittings, the Trident CT eliminates air leaks, optimizing analytical performance.

### Trident CT In-Line Reagent Additions Kit for non-HF solutions:

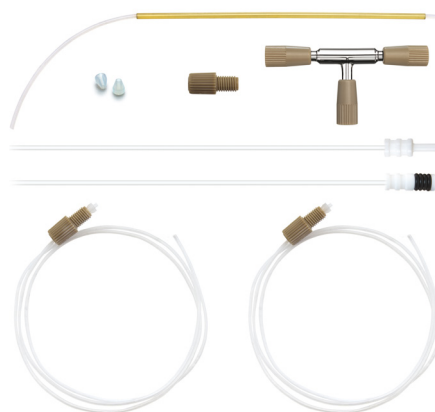

### The Trident CT features:

- Compact, efficient mixing chamber ensures complete mixing of the sample and reagent.
- CT fittings for a durable, leak-free seal on all connections.
- Zero dead volume connections.
- Completely modular so that damaged or lost components can easily be replaced.

Check the Trident Dilution Factor Calculator on our website to find out the sample and internal standard dilution factors for selected combinations of pump tubing.

The peristaltic pump tubing is not supplied as part of the Internal Standard Kit but can be ordered separately.

### Trident Internal Standard Kit for HF solutions:



### In-Line Reagent Additions Kits

Trident CT In-Line Reagent Additions Kit 60-703-1179

Trident Internal Standard Kit for HF (original design) 60-808-1150

[Click here](#) to view the consumables for the Trident CT™ In-Line Reagent Additions Kits.

## Laser Ablation

P/N: 21-809-4309



P/N: 70-803-1600



P/N: 31-808-4034



P/N: 20-809-4550



P/N: 21-809-2801



P/N: 31-808-4289



P/N: 31-808-4107



P/N: 31-808-3863  
OD: 4mm  
ID: 2mm



## S13 (13 mm) cup Adaptors

P/N: 31-800-1007  
ID: 4mm



P/N: 21-809-4140



P/N: 21-809-0965C  
OD: 6mm  
ID: 4mm



P/N: 31-808-3045  
OD: 4mm  
ID: 2mm



## GazFit Connectors



### GazFit Union Connectors (for rigid walled tubing)

GazFit Union 4mm (PKT.2)	GAZ-04U
GazFit Union 6mm (PKT.2)	GAZ-06U
GazFit Union 8mm (PKT.2)	GAZ-08U



### Standard GazFit Connectors (for soft walled tubing)

GazFit Connectors for 4mm OD side arm (PKT.4)	GAZ-04
GazFit Connectors for 5mm OD side arm (PKT.4)	GAZ-05
GazFit Connectors for 6mm OD side arm (PKT.4)	GAZ-06
GazFit Connectors for 8mm OD arm (PKT.2)	GAZ-08
GazFit Connectors, 2 for 6mm OD side arms, 2 for 4mm OD side arms (PKT.4)	GAZ-0604
GazFit Connectors for 6mm OD side arm with connection for 1/8inch ID tubing (PKT.4)	GAZ-06-3.2B

## Guardian™ Autosampler Probes

The unique design of the robust tip—which combines drip-resistance and built-in particle filtering—helps to prevent cross-contamination during probe movement and blockages in your nebulizer and capillary tubing. Constructed entirely from PEEK and PFA, the Guardian autosampler probe also provides exceptional resistance to strong acids and solvents. The Guardian probe has an ID of 1.0mm, with interchangeable UniFit sample capillaries that are available in IDs of 0.3, 0.50, 0.75 and 1.0mm.



### Benefits:

- Robust tip design eliminates crushed and damaged tips due to misalignment.
- Drip-resistance prevents cross contamination of samples, especially with oils.
- Built-in particle filtering holds back particulates from blocking the line.
- Completely inert design, all PEEK and PTFE construction.
- Interchangeable UniFit sample lines available in various IDs (e.g. 0.3, 0.50, 0.75 & 1.0mm)
- Designed to suit Teledyne Cetac, AimLab & Agilent SPS3 /SPS4 Autosamplers.

#### Suitable for Cetac, Aim Lab, PerkinElmer S20 Series and Agilent SPS3 / SPS4 Autosamplers

Guardian Probe for SPS3/SPS4/AIMS, 0.75mm Probe Connecting Line (Red)	70-803-1957
Guardian Probe Cetac ASX-200/500/800, 0.75mm Probe Connecting Line (Red)	70-803-1803
Guardian Probe for PerkinElmer S20 Series Autosampler with Holder, 0.75mm Probe Connecting Line (Red)	70-803-2097

#### Guardian Probe only

Guardian Probe for SPS3/SPS4/AIMS	70-803-2008
Guardian Probe for Cetac ASX-200/500/800 Series	70-803-1787
Guardian Probe for Cetac ASX-112FR	70-803-2029

#### Probe Connecting Lines for SPS3/SPS4/AIMS & Cetac ASX-200/500/800

Probe Connecting line 1.0mm ID (Green)	70-803-1721
Probe Connecting Line 0.75mm ID (Red)	70-803-1714
Probe Connecting Line 0.5mm ID (Blue)	70-803-1852
Probe Connecting Line 0.3mm ID (Black)	70-803-1853

#### Probe Connecting Lines for ASX-112FR

Probe Connecting Line 0.18mm ID (Black)	70-803-2030
Probe Connecting Line 0.18mm ID with EzyFit (Green/Black)	70-803-2085

## Autosampler Probes



### Suitable for Cetac ASX-200/500/800 Series and PerkinElmer S20 Series

PTFE Encapsulated Carbon Fibre Probe 0.25mm ID with EzyFit	70-803-1088
Polyimide sheathed Autosampler Probe 0.5mm ID	60-808-1186L
PTFE Encapsulated Carbon Fibre Probe 0.25mm ID	70-803-1523
PTFE Encapsulated Carbon Fibre Probe 0.5mm ID	70-803-0784
PTFE Encapsulated Carbon Fibre Probe 0.5mm ID with UniFit	70-803-1380
PTFE Encapsulated Carbon Fibre Probe 0.75mm ID with ratchet fitting	70-803-1443
PTFE Encapsulated Carbon Fibre Probe 0.75mm ID	70-803-1880
PTFE Encapsulated Carbon Fibre Probe 1.0mm ID with ratchet fitting	70-803-0793
PTFE Encapsulated Carbon Fibre Probe 1.0mm ID	70-803-1879

### For Cetac ASX 110

PFA sheathed Autosampler Probe 0.25mm ID with EzyFit	70-803-1072
PFA sheathed Autosampler Probe 0.25mm ID with UniFit	70-803-1073
PTFE Sheathed Carbon Fibre Probe 0.18mm ID with UniFit	70-803-1684
PTFE Encapsulated Carbon Fibre Probe 0.3mm ID with UniFit	70-803-1191
PTFE Encapsulated Carbon Fibre Probe 1.0mm ID	70-803-1182

### For Agilent® SPS 3/SPS 4

PTFE Encapsulated Carbon Fibre Probe 0.25mm ID	70-803-0910
PTFE Encapsulated Carbon Fibre Probe 0.50mm ID	70-803-0909
PTFE Encapsulated Carbon Fibre Probe 0.75mm ID	70-803-0908
PTFE Encapsulated Carbon Fibre Probe 1.0mm ID	70-803-0853

### For Agilent® I-AS

PTFE Encapsulated Carbon Fibre Probe 0.25mm ID with UniFit, 1100mm total length	60-703-1010
PTFE Encapsulated Carbon Fibre Probe 0.3mm ID with UniFit, 686 mm total length	60-703-1009
PTFE Encapsulated Carbon Fibre Probe 1.0mm ID	60-703-0533

### For PerkinElmer® S10 or AS93+

PTFE Encapsulated Carbon Fibre Probe 0.25mm ID	70-803-1071
PTFE Encapsulated Carbon Fibre Probe 0.5mm ID	70-803-1440
PTFE Encapsulated Carbon Fibre Probe 1.0mm ID	70-803-0816

### For Shimadzu®

PTFE Sheathed Carbon Fibre Probe 0.75mm ID with UniFit, for Shimadzu® AS-10	70-803-1477
---	-------------

## Glass DC Nebulizers

### SeaSpray

400µL/min uptake      A13-1-USS04X

### MicroMist

400µL/min uptake      A13-1-UM04X

200µL/min uptake      A13-1-UM02X

100µL/min uptake      A13-1-UM01Q

50µL/min uptake      A13-1-UM005Q

### Conikal

1mL/min uptake      A13-1-UC1X



## Quartz DC Nebulizers

### SeaSpray

1mL/min uptake      A13-1-QSS1



## DC Nebulizers for HF

### OpalMist

400µL/min uptake      A13-1-PFA04X

200µL/min uptake      A13-1-PFA02X

100µL/min uptake      A13-1-PFA01Q

50µL/min uptake      A13-1-PFA005Q



## DC Nebulizers for HE-SIS

### MicroMist HE

200µL/min uptake      C13-1-UFT02

200µL/min uptake      E13-1-UFT02



## Peltier Controlled Cyclonic Spray Chambers

Glass Spray Chamber      KT-1116

Quartz Spray Chamber      KT-1116Q

PFA Spray Chamber      KT-1116P



## Spray Chambers

### High Efficiency Sample Introduction System

HE-SIS for Agilent ICP-MS      KT-1155



### \*Twister

50mL Cyclonic with Aux.      20-809-2574HE

\*Requires adaptor KT-1104.



### Quartz Scott Style

For 7900 UHMI      20-809-4144



## Spray Chambers for HF

### \*Tracey PFA44

44ml Cyclonic with Aux.      20-809-2578

Spray Chamber Adaptor      KT-1104

\*Requires adaptor KT-1104.



## Torches

### Quartz Torches

with 1.0mm Injector      30-807-0558

with 1.5mm Injector      30-807-0557

with 2.0mm Injector      30-807-3608

with 2.5mm Injector      30-807-0556



### Torch Options

Quartz Torch Bonnet      31-808-2577

Quartz Connector with Dilution Port      31-808-3217

Quartz Connector with 45deg Dilution Port      31-808-3280

Straight Quartz Connector      31-808-3288

Clamp (PKT 2)      70-803-0846





**Torches**

(continued)

**Semi-Demountable Torch**

with 2.4mm Quartz Injector 30-808-3853



**Torch Options**

Semi-Demountable Torch body 31-808-3857



1.0mm Tapered Quartz Injector 31-808-4172

1.5mm Tapered Quartz Injector 31-808-4173



2.4mm Tapered Quartz Injector 31-808-4168

1.0 mm Tapered Alumina Injector 31-808-4169



1.5 mm Tapered Alumina Injector 31-808-4170

2.4mm Tapered Alumina Injector 31-808-3855

2.4mm Sapphire Capillary Injector 31-808-4159



Injector Adaptor 31-808-4129

Viton O-rings for FDT/SDT ball joints (PKT 10) 70-V-011



**RF Coils**

Copper 70-900-7800C

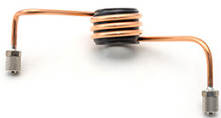

Silver 70-900-7800S



Gold 70-900-7800G



**RF Coil Installation Kit** 70-900-7500T



**Cones**

**Sampler Cones**

Nickel Sampler AT7701-Ni

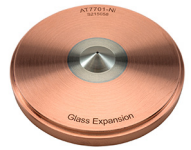

Nickel Sampler with Nickel plated base AT7701-Ni/Ni



Aluminium Sampler AT7701-Al



Platinum Sampler AT7706-Pt

Platinum Sampler (18 mm Insert) AT7706A-Pt



Platinum Sampler with Nickel plated base AT7706-Pt/NiP

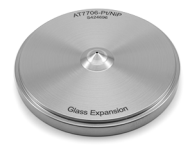

Platinum Sampler with solid Nickel base AT7706-Pt/Ni

Platinum Sampler (15mm insert) with Nickel base AT7706B-Pt/Ni



Platinum Sampler with Nickel plated base (Extended Life) AT7706L-Pt/NiP

**Skimmer Cones**

Nickel Skimmer for x-lens AT7902X-Ni



Aluminium Skimmer for x-lens AT7902X-Al



Platinum Skimmer for x-lens AT7908X-Pt



## Cones

(continued)

### Skimmer Cones (continued)

Platinum Skimmer with Nickel base for x-lens AT7908X-Pt/Ni

Nickel Skimmer for s-lens AT7702S-Ni

Copper Skimmer for s-lens AT7702S-Cu

Platinum Skimmer for s-lens AT7708S-Pt

Platinum Skimmer with Nickel base for s-lens AT7708S-Pt/Ni

Platinum Skimmer with Nickel base for m-lens AT8908M-Pt/Ni

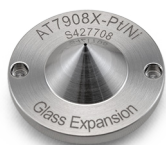

### Cone Options

Skimmer Cone Guard 70-803-1004

Long Life Shield Plate AT5004

Graphite Gasket (PKT 3) AT7703

Retaining Ring AT7704

Brass Skimmer Adaptor base for m lens AT7905M-BR

Brass Skimmer Adaptor base for x lens AT7905X-BR

Stainless Steel Skimmer Adaptor base for x lens AT7905X-SS

Captive Screw M4 for Skimmer Base (PKT 3) 70-803-2061



## Common Accessories

### Elegra Argon Humidifier

Elegra Dual Argon Humidifier 70-803-1273



Elegra Stand 70-803-1581



## Common Accessories

(continued)

### Guardian In-Line Filters

Guardian DC in-line non-return gas filter 70-803-1942

Guardian in-line sample filter 70-803-1108

Eluo Adaptor for Inline Filter 70-803-1160



### Trident Internal Standard Kits

Trident CT Standard Kit 60-703-1179

Standard Kit for HF 60-808-1150

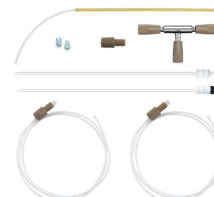

Magnifier Inspection Tool 70-803-1923



## Autosampler Probes (See page 20-21 for complete list of probes)

### For Agilent I-AS

PTFE Encapsulated Carbon Fibre Probe 0.25mm ID 60-703-1010

PTFE Encapsulated Carbon Fibre Probe 0.3mm ID 60-703-1009



### For Cetac ASX-200/500/800 Series

Guardian Probe 0.75mm Probe Connecting Line (Red) 70-803-1803

Polyimide sheathed Autosampler Probe 0.5mm ID 60-808-1186L

PTFE Encapsulated Carbon Fibre Probe 0.5mm ID 70-803-0784

PTFE Encapsulated Carbon Fibre Probe 0.75mm ID 70-803-1443

PTFE Encapsulated Carbon Fibre Probe 1.0mm ID 70-803-0793



### For SPS 3/SPS 4

Guardian Probe 0.75mm Probe Connecting Line (Red) 70-803-1957

PTFE Encapsulated Carbon Fibre Probe 0.75mm ID 70-803-0908

PTFE Encapsulated Carbon Fibre Probe 1.0mm ID 70-803-0853



### Glass DC Nebulizers

**SeaSpray**

400µL/min uptake      A13-1-USS04X

**MicroMist**

400µL/min uptake      A13-1-UM04X  
 200µL/min uptake      A13-1-UM02X  
 100µL/min uptake      A13-1-UM01Q  
 50µL/min uptake      A13-1-UM005Q

**Conikal**

1mL/min uptake      A13-1-UC1X



### Quartz DC Nebulizers

**SeaSpray**

1mL/min uptake      A13-1-QSS1



### DC Nebulizers for HF

**OpalMist**

400µL/min uptake      A13-1-PFA04X  
 200µL/min uptake      A13-1-PFA02X  
 100µL/min uptake      A13-1-PFA01Q  
 50µL/min uptake      A13-1-PFA005Q



### DC Nebulizers for HE-SIS

**MicroMist HE**

200µL/min uptake      C13-1-UFT02  
 200µL/min uptake      E13-1-UFT02



### Peltier Controlled Cyclonic Spray Chambers

Glass Spray Chamber      KT-1116  
 Quartz Spray Chamber      KT-1116Q  
 PFA Spray Chamber      KT-1116P



### Spray Chambers

**High Efficiency Sample Introduction System**

HE-SIS for Agilent ICP-MS      KT-1155



### Spray Chambers

**\*Twister**

50mL Cyclonic with Aux.      20-809-2574HE

\*Requires adaptor KT-1104.



**Quartz Scott Style**

For 7900 UHMI      20-809-4144



### Spray Chambers for HF

**\*Tracey PFA44**

44ml Cyclonic with Aux.      20-809-2578  
 Spray Chamber Adaptor      KT-1104

\*Requires adaptor KT-1104.



### Torches

**Quartz Torches**

with 1.0mm Injector      30-807-0558  
 with 1.5mm Injector      30-807-0557  
 with 2.0mm Injector      30-807-3608  
 with 2.5mm Injector      30-807-0556

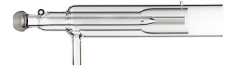

**Torch Options**

Quartz Torch Bonnet      31-808-2577  
 Quartz Connector with Dilution Port      31-808-3217  
 Quartz Connector with 45deg Dilution Port      31-808-3280  
 Straight Quartz Connector      31-808-3288  
 Clamp (PKT 2)      70-803-0846



## Torches

(continued)

### Semi-Demountable Torch

with 2.4mm Quartz Injector 30-808-3853



### Torch Options

Semi-Demountable Torch body 31-808-3857



1.0mm Tapered Quartz Injector 31-808-4172

1.5mm Tapered Quartz Injector 31-808-4173



2.4mm Tapered Quartz Injector 31-808-4168

1.0 mm Tapered Alumina Injector 31-808-4169



1.5 mm Tapered Alumina Injector 31-808-4170

2.4mm Tapered Alumina Injector 31-808-3855

2.4mm Sapphire Capillary Injector 31-808-4159



Injector Adaptor 31-808-4129

Viton O-rings for FDT/SDT ball joints (PKT 10) 70-V-011



## RF Coils

Copper 70-900-7800C



Silver 70-900-7800S



Gold 70-900-7800G



RF Coil Installation Kit 70-900-7500T



## Cones

### Sampler Cones

Nickel Sampler AT7701-Ni

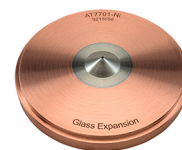

Nickel Sampler with Nickel plated base AT7701-Ni/Ni



Aluminium Sampler AT7701-Al



Platinum Sampler AT7706-Pt

Platinum Sampler (18 mm Insert) AT7706A-Pt



Platinum Sampler with Nickel plated base AT7706-Pt/NiP



Platinum Sampler with solid Nickel base AT7706-Pt/Ni

Platinum Sampler (15mm insert)with Nickel base AT7706B-Pt/Ni



Platinum Sampler with Nickel plated base (Extended Life) AT7706L-Pt/NiP

### Skimmer Cones

Nickel Skimmer for x-lens AT7902X-Ni



Aluminium Skimmer for x-lens AT7902X-Al



Platinum Skimmer for x-lens AT7908X-Pt



**Cones**

(continued)

**Skimmer Cones (continued)**

Platinum Skimmer with Nickel base for x-lens AT7908X-Pt/Ni

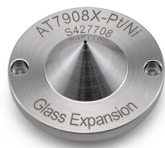

Nickel Skimmer for s-lens AT8902S-Ni



Copper Skimmer for s-lens AT8902S-Cu

Platinum Skimmer for s-lens AT8908S-Pt/Cu

Platinum Skimmer with Nickel base for s-lens AT8908S-Pt/Ni

Platinum Skimmer with Nickel base for m-lens AT8908M-Pt/Ni



**Cone Options**

Skimmer Cone Guard 70-803-1004

Long Life Shield Plate AT5004

Graphite Gasket (PKT 3) AT7703

Retaining Ring AT7704



**Common Accessories**

**Elegra Argon Humidifier**

Elegra Dual Argon Humidifier 70-803-1273



Elegra Stand 70-803-1581



**Guardian In-Line Filters**

Guardian DC in-line non-return gas filter 70-803-1942

Guardian in-line sample filter 70-803-1108

Eluo Adaptor for Inline Filter 70-803-1160



**Common Accessories**

(continued)

**Trident Internal Standard Kits**

Trident CT Standard Kit 60-703-1179

Standard Kit for HF 60-808-1150

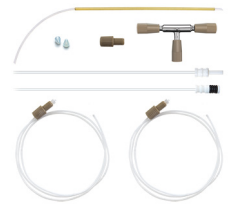

**Magnifier Inspection Tool** 70-803-1923



**Autosampler Probes** (See page 20-21 for complete list of probes)

**For Agilent I-AS**

PTFE Encapsulated Carbon Fibre Probe 0.25mm ID 60-703-1010

PTFE Encapsulated Carbon Fibre Probe 0.3mm ID 60-703-1009



**For Cetac ASX-200/500/800 Series**

Guardian Probe 0.75mm Probe Connecting Line (Red) 70-803-1803

Polyimide sheathed Autosampler Probe 0.5mm ID 60-808-1186L

PTFE Encapsulated Carbon Fibre Probe 0.5mm ID 70-803-0784

PTFE Encapsulated Carbon Fibre Probe 0.75mm ID 70-803-1443

PTFE Encapsulated Carbon Fibre Probe 1.0mm ID 70-803-0793



**For SPS 3/SPS 4**

Guardian Probe 0.75mm Probe Connecting Line (Red) 70-803-1957

PTFE Encapsulated Carbon Fibre Probe 0.75mm ID 70-803-0908

PTFE Encapsulated Carbon Fibre Probe 1.0mm ID 70-803-0853



## Glass DC Nebulizers

### SeaSpray

400µL/min uptake      A13-1-USS04X

### MicroMist

400µL/min uptake      A13-1-UM04X

200µL/min uptake      A13-1-UM02X

100µL/min uptake      A13-1-UM01Q

50µL/min uptake      A13-1-UM005Q

### Conikal

1mL/min uptake      A13-1-UC1X



## Quartz DC Nebulizers

### SeaSpray

1mL/min uptake      A13-1-QSS1



## DC Nebulizers for HF

### OpalMist

400µL/min uptake      A13-1-PFA04X

200µL/min uptake      A13-1-PFA02X

100µL/min uptake      A13-1-PFA01Q

50µL/min uptake      A13-1-PFA005Q



## DC Nebulizers for HE-SIS

### MicroMist HE

200µL/min uptake      C13-1-UFT02

200µL/min uptake      E13-1-UFT02



## IsoMist XR

### Programmable Temperature Cyclonic Spray Chamber

IsoMist XR Kit      KT-1103-XR

#### Comprises:

Glass Twister Spray Chamber      21-809-3186

Assembly (ROL)      20-809-5176

Mount      21-809-3765

Make-up Gas Adaptor      21-809-4024

Metal Ball Joint Clip      JC-13

UniFit Connector (PKT. 3)      UFT-2-86



## Peltier Controlled Cyclonic Spray Chambers

### For Agilent 7800

Glass Spray Chamber      KT-1206

Quartz Spray Chamber      KT-1206Q

PFA Spray Chamber      KT-1206P



### For Agilent 7850

Glass Spray Chamber      KT-1116

Quartz Spray Chamber      KT-1116Q

PFA Spray Chamber      KT-1116P



## Spray Chambers

### High Efficiency Sample Introduction System

HE-SIS for Agilent ICP-MS      KT-1155



### \*Twister

20mL Cyclonic with Aux.      20-809-2574HE

\*Requires adaptor KT-1104.



## Spray Chambers for HF

### \*Tracey PFA44

44ml Cyclonic with Aux.      20-809-2578

Spray Chamber Adaptor      KT-1104

\*Requires adaptor KT-1104.



## Torches

### Quartz Torches

with 1.0mm Injector	30-807-0558
with 1.5mm Injector	30-807-0557
with 2.0mm Injector	30-807-3608
with 2.5mm Injector	30-807-0556

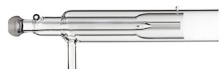

### Torch Options

Quartz Torch Bonnet	31-808-2577
Quartz Connector with Dilution Port	31-808-3217
Quartz Connector with 45deg Dilution Port	31-808-3280
Straight Quartz Connector	31-808-3288
Clamp (PKT 2)	70-803-0846



### Semi-Demountable Torch

with 2.4mm Quartz Injector	30-808-3853
----------------------------	-------------



### Torch Options

Semi-Demountable Torch body	31-808-3857
1.0mm Tapered Quartz Injector	31-808-4172
1.5mm Tapered Quartz Injector	31-808-4173
2.4mm Tapered Quartz Injector	31-808-4168
1.0 mm Tapered Alumina Injector	31-808-4169
1.5 mm Tapered Alumina Injector	31-808-4170
2.4mm Tapered Alumina Injector	31-808-3855
2.4mm Sapphire Capillary Injector	31-808-4159
Injector Adaptor	31-808-4129



Viton O-rings for FDT/SDT ball joints (PKT 10)	70-V-011
--	----------



## RF Coils

Copper	70-900-7800C
--------	--------------



Silver	70-900-7800S
--------	--------------



Gold	70-900-7800G
------	--------------



RF Coil Installation Kit	70-900-7500T
--------------------------	--------------



## Cones

### Sampler Cones

Nickel Sampler	AT7701-Ni
----------------	-----------

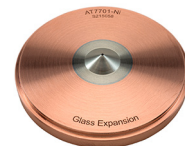

Nickel Sampler with Nickel plated base	AT7701-Ni/Ni
--	--------------



Aluminium Sampler	AT7701-Al
-------------------	-----------



Platinum Sampler	AT7706-Pt
------------------	-----------



Platinum Sampler (18 mm Insert)	AT7706A-Pt
---------------------------------	------------



Platinum Sampler with Nickel plated base	AT7706-Pt/NiP
--	---------------

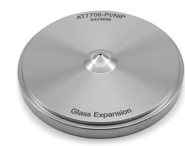

## Cones

(continued)

### Sampler Cones (continued)

Platinum Sampler with solid Nickel base	AT7706-Pt/Ni
Platinum Sampler (15mm insert) with Nickel base	AT7706B-Pt/Ni
Platinum Sampler with Nickel plated base (Extended Life)	AT7706L-Pt/NiP



### Skimmer Cones

Nickel Skimmer for x-lens	AT7702X-Ni
Aluminium Skimmer for x-lens	AT7702X-Al



Platinum Skimmer for x-lens	AT7708X-Pt
-----------------------------	------------



Platinum Skimmer with Nickel base for x-lens	AT7708X-Pt/Ni
--	---------------



### Cone Options

Skimmer Cone Guard	70-803-1008
Long Life Shield Plate	AT5004
Graphite Gasket (PKT 3)	AT7703
Retaining Ring	AT7704



## Common Accessories

### Elegra Argon Humidifier

Elegra Dual Argon Humidifier	70-803-1273
Elegra Stand	70-803-1581



### Guardian In-Line Filters

Guardian DC in-line non-return gas filter	70-803-1942
Guardian in-line sample filter	70-803-1108
Eluo Adaptor for Inline Filter	70-803-1160



## Common Accessories

(continued)

### Trident Internal Standard Kits

Trident CT Standard Kit	60-703-1179
Standard Kit for HF	60-808-1150

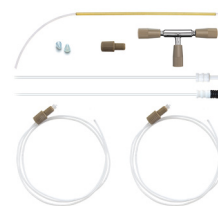

### Magnifier Inspection Tool 70-803-1923



## Autosampler Probes (See page 20-21 for complete list of probes)

### For Agilent I-AS

PTFE Encapsulated Carbon Fibre Probe 0.25mm ID	60-703-1010
PTFE Encapsulated Carbon Fibre Probe 0.3mm ID	60-703-1009



### For Cetac ASX-200/500/800 Series

Guardian Probe 0.75mm	
Probe Connecting Line (Red)	70-803-1803
Polyimide sheathed Autosampler Probe 0.5mm ID	60-808-1186L
PTFE Encapsulated Carbon Fibre Probe 0.5mm ID	70-803-0784
PTFE Encapsulated Carbon Fibre Probe 0.75mm ID	70-803-1443
PTFE Encapsulated Carbon Fibre Probe 1.0mm ID	70-803-0793



### For SPS 3/SPS 4

Guardian Probe 0.75mm	
Probe Connecting Line (Red)	70-803-1957
PTFE Encapsulated Carbon Fibre Probe 0.75mm ID	70-803-0908
PTFE Encapsulated Carbon Fibre Probe 1.0mm ID	70-803-0853





### Glass DC Nebulizers

#### SeaSpray

400µL/min uptake      A13-1-USS04X

#### MicroMist

400µL/min uptake      A13-1-UM04X  
 200µL/min uptake      A13-1-UM02X  
 100µL/min uptake      A13-1-UM01Q  
 50µL/min uptake      A13-1-UM005Q



#### Conikal

1mL/min uptake      A13-1-UC1X

### Quartz DC Nebulizers

#### SeaSpray

1mL/min uptake      A13-1-QSS1



### DC Nebulizers for HF

#### OpalMist

400µL/min uptake      A13-1-PFA04X  
 200µL/min uptake      A13-1-PFA02X  
 100µL/min uptake      A13-1-PFA01Q  
 50µL/min uptake      A13-1-PFA005Q



### DC Nebulizers for HE-SIS

#### MicroMist HE

200µL/min uptake      C13-1-UFT02  
 200µL/min uptake      E13-1-UFT02



### IsoMist XR

#### Programmable Temperature Cyclonic Spray Chamber

IsoMist XR Kit      KT-1103-XR

#### Comprises:

Glass Twister Spray Chamber      21-809-3186  
 Assembly (ROL)      20-809-5176  
 Mount      21-809-3765  
 Make-up Gas Adaptor      21-809-4024  
 Metal Ball Joint Clip      JC-13  
 UniFit Connector (PKT. 3)      UFT-2-86



### Peltier Controlled Cyclonic Spray Chambers

Glass Spray Chamber      KT-1206  
 Quartz Spray Chamber      KT-1206Q  
 PFA Spray Chamber      KT-1206P



### Spray Chambers

#### High Efficiency Sample Introduction System

HE-SIS for Agilent ICP-MS      KT-1155



#### \*Twister

50mL Cyclonic with Aux.      20-809-2574HE

\*Requires adaptor KT-1104.



### Spray Chambers for HF

#### \*Tracey PFA44

44ml Cyclonic with Aux.      20-809-2578  
 Spray Chamber Adaptor      KT-1104

\*Requires adaptor KT-1104.



## Torches

### Quartz Torches

with 1.0mm Injector	30-807-0558
with 1.5mm Injector	30-807-0557
with 2.0mm Injector	30-807-3608
with 2.5mm Injector	30-807-0556

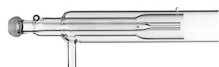

### Torch Options

Quartz Torch Bonnet	31-808-2577
Quartz Connector with Dilution Port	31-808-3217
Quartz Connector with 45deg Dilution Port	31-808-3280
Straight Quartz Connector	31-808-3288
Clamp (PKT 2)	70-803-0846



### Semi-Demountable Torch

with 2.4mm Quartz Injector	30-808-3853
----------------------------	-------------



### Torch Options

Semi-Demountable Torch body	31-808-3857
1.0mm Tapered Quartz Injector	31-808-4172
1.5mm Tapered Quartz Injector	31-808-4173
2.4mm Tapered Quartz Injector	31-808-4168
1.0 mm Tapered Alumina Injector	31-808-4169
1.5 mm Tapered Alumina Injector	31-808-4170
2.4mm Tapered Alumina Injector	31-808-3855
2.4mm Sapphire Capillary Injector	31-808-4159
Injector Adaptor	31-808-4129



Viton O-rings for FDT/SDT ball joints (PKT 10)	70-V-011
--	----------



## RF Coils

Copper	70-900-7700C
--------	--------------



Silver	70-900-7700S
--------	--------------



Gold	70-900-7700G
------	--------------



RF Coil Installation Kit	70-900-7500T
--------------------------	--------------



## Cones

### Sampler Cones

Nickel Sampler	AT7701-Ni
----------------	-----------



Nickel Sampler with Nickel plated base	AT7701-Ni/Ni
--	--------------

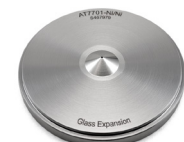

Aluminium Sampler	AT7701-Al
-------------------	-----------



Platinum Sampler	AT7706-Pt
------------------	-----------



Platinum Sampler (18 mm Insert)	AT7706A-Pt
---------------------------------	------------



Platinum Sampler with Nickel plated base	AT7706-Pt/NiP
--	---------------

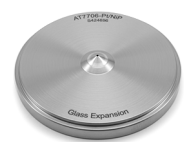

**Cones**

(continued)

**Sampler Cones (continued)**

Platinum Sampler with solid Nickel base	AT7706-Pt/Ni
Platinum Sampler (15mm insert) with Nickel base	AT7706B-Pt/Ni
Platinum Sampler with Nickel plated base (Extended Life)	AT7706L-Pt/NiP

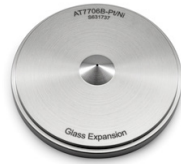

**Skimmer Cones**

Nickel Skimmer for x-lens	AT7702X-Ni
Aluminium Skimmer for x-lens	AT7702X-Al



Platinum Skimmer for x-lens	AT7708X-Pt
-----------------------------	------------



Platinum Skimmer with Nickel base for x-lens	AT7708X-Pt/Ni
--	---------------

Nickel Skimmer for s-lens	AT7702S-Ni
---------------------------	------------

Platinum Skimmer for s-lens	AT7708S-Pt
-----------------------------	------------



Platinum Skimmer with Nickel base for s-lens	AT7708S-Pt/Ni
--	---------------

**Cone Options**

Skimmer Cone Guard for x-lens	70-803-1008
Skimmer Cone Guard for s-lens	70-803-1004
Long Life Shield Plate	AT5004
Retaining Ring	AT7704
Graphite Gasket (PKT 3)	AT7703



**Common Accessories**

**Elegra Argon Humidifier**

Elegra Dual Argon Humidifier	70-803-1273
Elegra Stand	70-803-1581



**Common Accessories**

(continued)

**Guardian In-Line Filters**

Guardian DC in-line non-return gas filter	70-803-1942
Guardian in-line sample filter	70-803-1108
Eluo Adaptor for Inline Filter	70-803-1160



**Trident Internal Standard Kits**

Trident CT Standard Kit	60-703-1179
Standard Kit for HF	60-808-1150

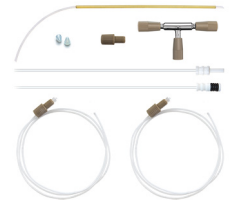

**Magnifier Inspection Tool** 70-803-1923



**Autosampler Probes** (See page 20-21 for complete list of probes)

**For Agilent I-AS**

PTFE Encapsulated Carbon Fibre Probe 0.25mm ID	60-703-1010
PTFE Encapsulated Carbon Fibre Probe 0.3mm ID	60-703-1009



**For Cetac ASX-200/500/800 Series**

Guardian Probe 0.75mm Probe Connecting Line (Red)	70-803-1803
Polyimide sheathed Autosampler Probe 0.5mm ID	60-808-1186L
PTFE Encapsulated Carbon Fibre Probe 0.5mm ID	70-803-0784
PTFE Encapsulated Carbon Fibre Probe 0.75mm ID	70-803-1443
PTFE Encapsulated Carbon Fibre Probe 1.0mm ID	70-803-0793



**For SPS 3/SPS 4**

Guardian Probe 0.75mm Probe Connecting Line (Red)	70-803-1957
PTFE Encapsulated Carbon Fibre Probe 0.75mm ID	70-803-0908
PTFE Encapsulated Carbon Fibre Probe 1.0mm ID	70-803-0853



## Glass DC Nebulizers

### SeaSpray

2mL/min uptake	A13-07-USS2
400µL/min uptake	A13-07-USS04

### MicroMist

400µL/min uptake	A13-07-UM04
200µL/min uptake	A13-07-UM02

### Conikal

2mL/min uptake	A13-07-UC2
1mL/min uptake	A13-07-UC1

### Slurry

4mL/min uptake	A13-07-US6
----------------	------------



## Spray Chambers

### Twister

50mL Cyclonic	20-809-9199HE
---------------	---------------



### Tracey

50mL Cyclonic	20-808-8882HE
---------------	---------------



## DC Nebulizers for HF

### DuraMist

1mL/min uptake	A13-07-DM1
400µL/min uptake	A13-07-DM04



### OpalMist

2mL/min uptake	A13-07-PFA2
600µL/min uptake	A13-07-PFA06
200µL/min uptake	A13-07-PFA02
100µL/min uptake	A13-07-PFA01
50µL/min uptake	A13-07-PFA005



### VeeSpray

0.6 - 3mL/min uptake	A13-07-CV6
----------------------	------------



## HydraMist Simultaneous Cold Vapor/ Pneumatic Nebulization Spray Chamber

Hydride Kit	KT-1157
-------------	---------



## Spray Chambers for HF

### Twister TFE Spray Chamber

50mL Cyclonic	20-809-3452
---------------	-------------



### Tracey TFE Spray Chamber

50mL Cyclonic	20-809-2507
---------------	-------------



## IsoMist XR

### Programmable Temperature Cyclonic Spray Chamber

IsoMist XR Kit	KT-1137-XR
----------------	------------

#### Comprises:

Glass Twister Spray Chamber	21-809-3186
Assembly (ROL)	20-809-5176
PuraFlex Transfer Tube	21-809-4038
Metal Ball Joint Clip	JC-13
UniFit Right Angle Connector (PKT 3)	GAZ-04-90



**Torches**

**D-Torch**

SVDV/VDV 30-808-3560 



**Comprises:**

- Base and Inner Tube 31-808-3568
- Quartz Outer Tube 31-808-3570
- Retaining Ring 31-808-3566
- Injector Ferrule 31-808-2962
- Injector Adaptor 31-808-3578
- RV 30-808-3590

**Comprises:**

- Base and Inner Tube 31-808-3568
- Quartz Outer Tube 31-808-3582
- Retaining Ring 31-808-3566
- Injector Ferrule 31-808-2962
- Injector Adaptor 31-808-3578

**D-Torch Options:**

- Ceramic Outer Tube for SVDV/VDV 31-808-3580 
- Ceramic Outer Tube for RV 31-808-3586
- Quartz Outer Tube for SVDV/VDV 31-808-3570 
- Quartz Outer Tube for RV 31-808-3582
- O-ring Kit 70-803-1500
- Ignition Enhancer 31-808-4020



**Quartz Torch**

- SVDV/VDV 31-808-3557 
- RV 31-808-3556
- Retaining Ring 31-808-3563 
- Pre-Optic Window Axial 70-803-1968
- Pre-Optic Window Radial 70-803-1969
- O-ring for Window Axial (PKT 5) 70-803-2794 
- Pre-optics cone 70-803-2751

**Torches**

(continued)

**Tapered Injectors**

- Quartz Injector 0.8mm 31-808-3738 
- Quartz Injector 1.4mm 31-808-3583
- Quartz Injector 1.8mm 31-808-3576
- Quartz Injector 2.4mm 31-808-3584
- Alumina Injector 1.5mm 31-808-3725 
- Alumina Injector 1.8mm 31-808-3585
- Alumina Injector 2.4mm 31-808-3722

**Injectors for Agilent FDT**

- Quartz Injector 0.8mm 31-808-4357
- Quartz Injector 1.4mm 31-808-4354
- Quartz Injector 1.8mm 31-808-4355 
- Quartz Injector 2.4mm 31-808-4356
- Alumina Injector 1.8mm 31-808-4358

**RF Coils**

- Silver 70-900-5100S
- Gold 70-900-5100G
- Copper 70-900-5100C
- RF Coil Installation Kit 70-900-5100T 

## Common Accessories

### Elegra Argon Humidifier

Elegra Argon Humidifier 70-803-1268



### Guardian In-Line Filters

Guardian DC in-line non-return gas filter 70-803-1942

Guardian in-line sample filter 70-803-1108

Eluo Adaptor for Inline Filter 70-803-1160



### Trident Internal Standard Kits

Trident CT Standard Kit 60-703-1179

Standard Kit for HF 60-808-1150

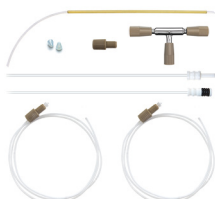

### Magnifier Inspection Tool 70-803-1923



## Autosampler Probes (See page 20-21 for complete list of probes)

### For Cetac ASX-200/500/800 Series

Guardian Probe 0.75mm  
Probe Connecting Line (Red) 70-803-1803

Polyimide sheathed Autosampler Probe  
0.5mm ID 60-808-1186L

PTFE Encapsulated Carbon Fibre Probe  
0.5mm ID 70-803-0784

PTFE Encapsulated Carbon Fibre Probe  
0.75mm ID 70-803-1443

PTFE Encapsulated Carbon Fibre Probe  
1.0mm ID 70-803-0793



### For SPS 3/SPS 4

Guardian Probe 0.75mm  
Probe Connecting Line (Red) 70-803-1957

PTFE Encapsulated Carbon Fibre Probe  
0.75mm ID 70-803-0908

PTFE Encapsulated Carbon Fibre Probe  
1.0mm ID 70-803-0853



### Glass DC Nebulizers

#### SeaSpray

2mL/min uptake	A13-07-USS2
1mL/min uptake	A13-05-USS1

#### MicroMist

400µL/min uptake	A13-05-UM04
------------------	-------------

#### Conikal

1mL/min uptake	A13-05-UC1
----------------	------------

#### Slurry

4mL/min uptake	A13-07-US6
----------------	------------



### DC Nebulizers for HF

#### DuraMist

1mL/min uptake	A13-05-DM1
400µL/min uptake	A13-05-DM04



#### VeeSpray

0.6 - 3mL/min uptake	A13-07-CV6
----------------------	------------



### IsoMist XR

#### Programmable Temperature Cyclonic Spray Chamber

IsoMist XR Kit	KT-1135-XR
----------------	------------

#### Comprises:

Glass Twister Spray Chamber Assembly (LOL)	21-809-3185
PuraFlex Transfer Tube	21-809-2962
Metal Ball Joint Clip	JC-13
UniFit Right Angle Connector (PKT 3)	GAZ-04-90



### Spray Chambers

#### HydraMist Simultaneous Cold Vapor/ Pneumatic Nebulization Spray Chamber

Hydride Kit	KT-1157
-------------	---------



#### Twister

50mL Cyclonic	20-809-0222HE
---------------	---------------



#### Tracey

50mL Cyclonic	20-808-8882HE
---------------	---------------



#### Cinnabar

20mL Cyclonic	20-809-0164HE
---------------	---------------



### Spray Chambers for HF

#### Tracey TFE Spray Chamber

50mL Cyclonic	20-809-2506
---------------	-------------



#### PuraFlex Transfer Tube

21-809-2962
-------------



## Torches

### Fully Demountable Torch

Torch Body 31-808-8896



### Fully Demountable Torch Options:

Quartz Outer Tube 31-808-8020



Syalon Outer Tube 31-808-0023

Quartz Inner Tube 31-808-8145



Alumina Inner Tube 31-808-0017

Ball Joint Adaptor 31-807-0018

Torch Bonnet - Large 31-808-3607

Radial Purge Window 31-808-8098

O-rings for Glass Body (PKT 10) 70-4X2.5V75

Viton O-rings for FDT/SDT Ball Joints (PKT 10) 70-V-011

PTFE Coated Viton O-rings for Cyclonics/Nebulizer Seal (PKT 10) VT-009

EzyGlide Cloth 70-EZG-CLOTH



### Tapered Injectors

Quartz Injector 1.0mm 31-808-0009



Quartz Injector 2.0mm 31-808-0008

Alumina Injector 2.0mm 31-808-0027



## Common Accessories

### Elegra Argon Humidifier

Elegra Argon Humidifier 70-803-1266



### Guardian In-Line Filters

Guardian in-line sample filter 70-803-1108

Eluo Adaptor for Inline Filter 70-803-1160



## Common Accessories

(continued)

### Trident Internal Standard Kits

Trident CT Standard Kit 60-703-1179

Standard Kit for HF 60-808-1150

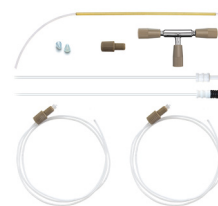

### Magnifier Inspection Tool 70-803-1923



## Autosampler Probes (See page 20-21 for complete list of probes)

### For Cetac ASX-200/500/800 Series

Guardian Probe 0.75mm

Probe Connecting Line (Red) 70-803-1803

Polyimide sheathed Autosampler Probe 0.5mm ID 60-808-1186L

PTFE Encapsulated Carbon Fibre Probe 0.5mm ID 70-803-0784

PTFE Encapsulated Carbon Fibre Probe 0.75mm ID 70-803-1443

PTFE Encapsulated Carbon Fibre Probe 1.0mm ID 70-803-0793



### For SPS 3/SPS 4

Guardian Probe 0.75mm

Probe Connecting Line (Red) 70-803-1957

PTFE Encapsulated Carbon Fibre Probe 0.75mm ID 70-803-0908

PTFE Encapsulated Carbon Fibre Probe 1.0mm ID 70-803-0853





### Glass DC Nebulizers

#### SeaSpray

400µL/min uptake      A52-1-USS04

#### MicroMist

400µL/min uptake      A52-1-UM04

200µL/min uptake      A52-1-UM02

100µL/min uptake      A52-1-UM01



### DC Nebulizers for HF

#### OpalMist

50µL/min uptake      A52-1-PFA005



### DC Nebulizers for HE-SIS

#### MicroMist HE

200µL/min uptake      C52-1-UFT02



### Spray Chambers

#### High Efficiency Sample Introduction System

HE-SIS for Nu Vitesse      KT-1219



#### Twister

50mL Cyclonic      20-809-0495HE



### Torches

#### Quartz Torch

with 1.5mm Injector      30-807-0560

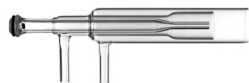

#### Viton O-rings for FDT/SDT

ball joints (PKT 10)      70-V-011



### Cones

#### Sampler Cones

Nickel Sampler  
Version A, Wet Plasma      NU1011A-Ni



Nickel Dry Sampler  
with Copper Core      NU1011B-Ni



#### Skimmer Cones

Nickel Skimmer  
Version A, Wet Plasma      NU1004A-Ni



Nickel Dry Skimmer      NU1014B-Ni

### Common Accessories

#### Guardian In-Line Filters

Guardian DC in-line non-return  
gas filter      70-803-1942



#### Trident Internal Standard Kits

Trident CT Standard Kit      60-703-1179

Standard Kit for HF      60-808-1150

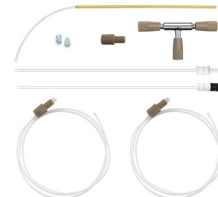

Magnifier Inspection Tool      70-803-1923



## Glass DC Nebulizers

### SeaSpray

2mL/min uptake	A23-1-USS2
1mL/min uptake	A23-1-USS1
400µL/min uptake	A23-1-USS04

### MicroMist

400µL/min uptake	A23-1-UM04
200µL/min uptake	A23-1-UM02
100µL/min uptake	A23-1-UM01
50µL/min uptake	A23-1-UM005



## Quartz DC Nebulizers

### SeaSpray

1mL/min uptake	A23-1-QSS1
----------------	------------



## DC Nebulizers for HF

### OpalMist

400µL/min uptake	A23-1-PFA04
200µL/min uptake	A23-1-PFA02
100µL/min uptake	A23-1-PFA01
50µL/min uptake	A23-1-PFA005



## DC Nebulizers for HE-SIS

### MicroMist HE

200µL/min uptake	C23-1-UFT02
------------------	-------------



## Spray Chambers

### Twister

50mL Cyclonic	20-809-4417HE
50mL Cyclonic	20-809-4560
With Matrix Port	



### Tracey

50mL Cyclonic	20-809-4419HE
---------------	---------------



## Spray Chambers

### Cinnabar

20mL Cyclonic	20-809-4480HE
---------------	---------------



### High Efficiency Sample Introduction System

HE-SIS for PerkinElmer NexION	KT-1184
-------------------------------	---------

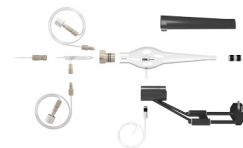

## Torches

### D-Torch

30-808-3927
-------------

#### Comprises:

Base and Inner Tube	31-808-3928
Quartz Outer Tube	31-808-3942
Retaining Ring	31-808-2818
Injector Adaptor	31-808-3980
Injector Ferrule	31-808-2962
Fastener Assembly	31-808-4130
Viton O-rings (PKT 10)	70-V-011
PTFE Coated Viton O-rings (PKT 10)	70-VT-012



### Quartz Injectors

Tapered 1.0mm	31-808-3423
Tapered 1.8mm	31-808-4005
Tapered 2.0mm	31-808-4006
Tapered 2.5mm	31-808-3302



### HF Resistant Injectors

Tapered Alumina 2.4mm	31-808-3205
Sapphire 2.4mm	31-808-3378



## Cones

### Sampler Cones

Nickel Sampler PE3011-Ni



Platinum Sampler PE3013-Pt

Platinum Sampler (18mm) PE3013A-Pt

Platinum Sampler Boron Free PE3013-Pt-BF



### Skimmer Cones

Nickel Skimmer PE4212-Ni

Platinum Skimmer PE4214-Pt

Nickel Hyper Skimmer PE4015-Ni

All Nickel Hyper Skimmer PE4016-Ni



### O-ring for NexION Hyper Skimmer Cone (pack of 5)

PE5125

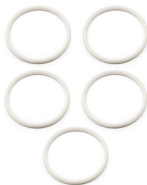

### ConeGuard Thread Protectors

Sampler Cone Guard For NexION 70-803-1024



### Gasket for Sampler Cone (pack of 5)

PE5111



## Common Accessories

### Elegra Argon Humidifier

Elegra Dual Argon Humidifier 70-803-1473



### Guardian In-Line Filters

Guardian DC in-line non-return gas filter 70-803-1942

Guardian in-line sample filter 70-803-1108

Eluo Adaptor for Inline Filter 70-803-1160



### Trident Internal Standard Kits

Trident CT Standard Kit 60-703-1179

Standard Kit for HF 60-808-1150

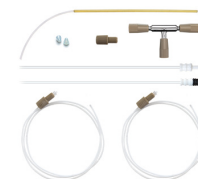

Magnifier Inspection Tool 70-803-1923



## Autosampler Probes (See page 20-21 for complete list of probes)

### Suitable for Cetac ASX-200/500/800 Series and PerkinElmer S20 Series

Guardian Probe 0.75mm Probe Connecting Line (Red) 70-803-1803

\*(suitable for Cetac only)



Guardian Probe with Holder, 0.75mm Probe Connecting Line (Red) 70-803-2097

\*(suitable for PerkinElmer S20 Series only)



Polyimide sheathed Autosampler Probe 0.5mm ID 60-808-1186L

PTFE Encapsulated Carbon Fibre Probe 0.5mm ID 70-803-0784

PTFE Encapsulated Carbon Fibre Probe 0.75mm ID 70-803-1443

PTFE Encapsulated Carbon Fibre Probe 1.0mm ID 70-803-0793



## Glass DC Nebulizers

### SeaSpray

2mL/min uptake	A23-1-USS2
1mL/min uptake	A23-1-USS1
400µL/min uptake	A23-1-USS04

### MicroMist

400µL/min uptake	A23-1-UM04
200µL/min uptake	A23-1-UM02
100µL/min uptake	A23-1-UM01
50µL/min uptake	A23-1-UM005



## Quartz DC Nebulizers

### SeaSpray

1mL/min uptake	A23-1-QSS1
----------------	------------



## DC Nebulizers for HF

### OpalMist

400µL/min uptake	A23-1-PFA04
200µL/min uptake	A23-1-PFA02
100µL/min uptake	A23-1-PFA01
50µL/min uptake	A23-1-PFA005



## DC Nebulizers for HE-SIS

### MicroMist HE

200µL/min uptake	C23-1-UFT02
------------------	-------------



## Spray Chambers

### Twister

50mL Cyclonic	20-809-4417HE
50mL Cyclonic	20-809-4560
With Matrix Port	



### Tracey

50mL Cyclonic	20-809-4419HE
---------------	---------------



## Spray Chambers

### Cinnabar

20mL Cyclonic	20-809-4480HE
---------------	---------------



### High Efficiency Sample Introduction System

HE-SIS for PerkinElmer NexION	KT-1184
-------------------------------	---------

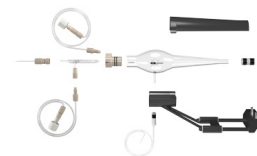

## Torches

### D-Torch

30-808-3927
-------------

#### Comprises:

Base and Inner Tube	31-808-3928
Quartz Outer Tube	31-808-3942
Retaining Ring	31-808-2818
Injector Adaptor	31-808-3980
Injector Ferrule	31-808-2962
Fastener Assembly	31-808-4130
Viton O-rings (PKT 10)	70-V-011
PTFE Coated Viton O-rings (PKT 10)	70-VT-012



### Quartz Injectors

Tapered 1.0mm	31-808-3423
Tapered 1.8mm	31-808-4005
Tapered 2.0mm	31-808-4006
Tapered 2.5mm	31-808-3302



### HF Resistant Injectors

Tapered Alumina 2.4mm	31-808-3205
Sapphire 2.4mm	31-808-3378



**Cones**

**Sampler Cones**

Nickel Sampler PE3011-Ni



Platinum Sampler PE3013-Pt

Platinum Sampler (18mm) PE3013A-Pt

Platinum Sampler Boron Free PE3013-Pt-BF



**Skimmer Cones**

Nickel Skimmer PE4012-Ni

Platinum Skimmer PE4014-Pt

Nickel Hyper Skimmer PE4015-Ni

All Nickel Hyper Skimmer PE4016-Ni



**O-ring for NexION Hyper Skimmer Cone (pack of 5)**

PE5125



**ConeGuard Thread Protectors**

Sampler Cone Guard For NexION 70-803-1024

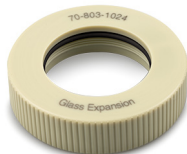

**Gasket for Sampler Cone (pack of 5)**

PE5111



**Common Accessories**

**Elegra Argon Humidifier**

Elegra Dual Argon Humidifier 70-803-1473



**Guardian In-Line Filters**

Guardian DC in-line non-return gas filter 70-803-1942

Guardian in-line sample filter 70-803-1108

Eluo Adaptor for Inline Filter 70-803-1160



**Trident Internal Standard Kits**

Trident CT Standard Kit 60-703-1179

Standard Kit for HF 60-808-1150

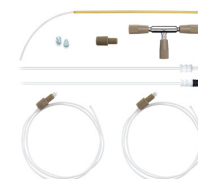

**Magnifier Inspection Tool 70-803-1923**



**Autosampler Probes** (See page 20-21 for complete list of probes)

**Suitable for Cetac ASX-200/500/800 Series and PerkinElmer S20 Series**

Guardian Probe 0.75mm Probe Connecting Line (Red) 70-803-1803  
\*(suitable for Cetac only)



Guardian Probe with Holder, 0.75mm Probe Connecting Line (Red) 70-803-2097  
\*(suitable for PerkinElmer S20 Series only)



Polyimide sheathed Autosampler Probe 0.5mm ID 60-808-1186L

PTFE Encapsulated Carbon Fibre Probe 0.5mm ID 70-803-0784

PTFE Encapsulated Carbon Fibre Probe 0.75mm ID 70-803-1443

PTFE Encapsulated Carbon Fibre Probe 1.0mm ID 70-803-0793



## Glass DC Nebulizers

### SeaSpray

2mL/min uptake	A23-1-USS2
1mL/min uptake	A23-1-USS1
400µL/min uptake	A23-1-USS04

### MicroMist

400µL/min uptake	A23-1-UM04
200µL/min uptake	A23-1-UM02
100µL/min uptake	A23-1-UM01
50µL/min uptake	A23-1-UM005



## Quartz DC Nebulizers

### SeaSpray

1mL/min uptake	A23-1-QSS1
----------------	------------



## DC Nebulizers for HF

### OpalMist

400µL/min uptake	A23-1-PFA04
200µL/min uptake	A23-1-PFA02
100µL/min uptake	A23-1-PFA01
50µL/min uptake	A23-1-PFA005



## DC Nebulizers for HE-SIS

### MicroMist HE

200µL/min uptake	C23-1-UFT02
------------------	-------------



## Spray Chambers

### Twister

50mL Cyclonic	20-809-4417HE
50mL Cyclonic With Matrix Port	20-809-4560



### Tracey

50mL Cyclonic	20-809-4419HE
---------------	---------------



## Spray Chambers

### Cinnabar

20mL Cyclonic	20-809-4480HE
---------------	---------------



### High Efficiency Sample Introduction System

HE-SIS for PerkinElmer NexION	KT-1184
-------------------------------	---------

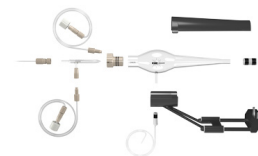

## Torches

### D-Torch

30-808-3927
-------------



### Comprises:

Base and Inner Tube	31-808-3928
Quartz Outer Tube	31-808-3942
Retaining Ring	31-808-2818
Injector Adaptor	31-808-3980
Injector Ferrule	31-808-2962
Fastener Assembly	31-808-4130
Viton O-rings (PKT 10)	70-V-011
PTFE Coated Viton O-rings (PKT 10)	70-VT-012

### Quartz Injectors

Tapered 1.0mm	31-808-3423
Tapered 1.8mm	31-808-4005
Tapered 2.0mm	31-808-4006
Tapered 2.5mm	31-808-3302



### HF Resistant Injectors

Tapered Alumina 2.4mm	31-808-3205
Sapphire 2.4mm	31-808-3378



**Cones**

**Sampler Cones**

Nickel Sampler PE3011-Ni



Aluminium Sampler PE3011-AI

Platinum Sampler PE3013-Pt

Platinum Sampler (18mm) PE3013A-Pt

Platinum Sampler Boron Free PE3013-Pt-BF



**Skimmer Cones**

Nickel Skimmer PE3012-Ni



Aluminium Skimmer PE3012-AI

Platinum Skimmer PE3014-Pt

Platinum Skimmer Boron Free PE3014-Pt-BF

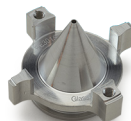

Aluminium Hyper Skimmer PE3015-AI

Nickel Hyper Skimmer PE3015-Ni

Platinum Hyper Skimmer PE3015-Pt/Ni

**O-ring for NexION Hyper Skimmer Cone (pack of 5)** PE5115



**Screw for NexION Hyper Skimmer Cone (pack of 2)** PE5116



**ConeGuard Thread Protectors**

Sampler Cone Guard For NexION 70-803-1024



Skimmer Cone Guard For NexION 70-803-1026

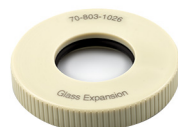

**Gasket for Sampler Cone (pack of 5)** PE5111



**Common Accessories**

**Elegra Argon Humidifier**

Elegra Dual Argon Humidifier 70-803-1473



**Guardian In-Line Filters**

Guardian DC in-line non-return gas filter 70-803-1942

Guardian in-line sample filter 70-803-1108

Eluo Adaptor for Inline Filter 70-803-1160



**Trident Internal Standard Kits**

Trident CT Standard Kit 60-703-1179

Standard Kit for HF 60-808-1150

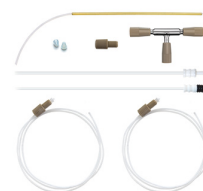

**Magnifier Inspection Tool** 70-803-1923



**Autosampler Probes** (See page 20-21 for complete list of probes)

**Suitable for Cetac ASX-200/500/800 Series and PerkinElmer S20 Series**

Guardian Probe 0.75mm Probe Connecting Line (Red) 70-803-1803

\*(suitable for Cetac only)



Guardian Probe with Holder, 0.75mm Probe Connecting Line (Red) 70-803-2097

\*(suitable for PerkinElmer S20 Series only)



Polyimide sheathed Autosampler Probe 0.5mm ID 60-808-1186L

PTFE Encapsulated Carbon Fibre Probe 0.5mm ID 70-803-0784

PTFE Encapsulated Carbon Fibre Probe 0.75mm ID 70-803-1443

PTFE Encapsulated Carbon Fibre Probe 1.0mm ID 70-803-0793



## Glass DC Nebulizers

### SeaSpray

1mL/min uptake	A22-1-USS1
400µL/min uptake	A22-1-USS04

### MicroMist

400µL/min uptake	A22-1-UM04
200µL/min uptake	A22-1-UM02
100µL/min uptake	A22-1-UM01



## DC Nebulizers for HF

### OpalMist

400µL/min uptake	A22-1-PFA04
200µL/min uptake	A22-1-PFA02
100µL/min uptake	A22-1-PFA01
50µL/min uptake	A22-1-PFA005



## DC Nebulizers for HE-SIS

### MicroMist HE

200µL/min uptake	C22-1-UFT02
------------------	-------------



## Spray Chambers

### Twister

50mL Cyclonic (2.4mm Aux. Port) 90deg Screw Mount	20-809-3854HE
---	---------------



### Twister

50mL Cyclonic with Screw Mount	20-809-3892HE
-----------------------------------	---------------



### Twinnabar

20mL Cyclonic	20-809-3650HE
---------------	---------------



## Spray Chambers for HF

### Cinnabar

20mL Cyclonic	20-809-3709HE
---------------	---------------



### Tracey PFA44

44mL Cyclonic	20-809-3713
---------------	-------------



### High Efficiency Sample Introduction System

HE-SIS for PerkinElmer NexION 300/350	KT-1204
--	---------



## Torches

### D-Torch

30-807-0540
-------------

#### Comprises:

Base and Inner Tube	31-808-2847
Quartz Outer Tube	31-808-2848
Retaining Ring	31-808-2818



### D-Torch for HF

30-808-2937
-------------

#### Comprises:

Base and Inner Tube	31-808-2847
Ceramic Outer Tube	31-808-2849
Retaining Ring	31-808-2818



#### D-Torch Options:

Quartz Outer Tube	31-808-2848
Ceramic Outer Tube	31-808-2849

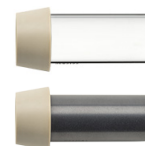



## Torches

(continued)

## Quartz Torch

Standard Quartz Torch	30-808-8107
High Efficiency Quartz Torch	31-808-2784



## Quartz Injectors (non DRC)

Tapered Quartz Injector 1.5mm	31-807-0006
Tapered Quartz Injector 1.8mm	31-807-0005
Tapered Quartz Injector 2.0mm	31-807-0004



These injectors are compatible with both D-Torch and standard torch. They are suitable for torch adaptor 31-808-2825.

## Quartz Injectors (DRC Versions)

Tapered Quartz Injector with Ball Joint, 0.85mm	31-808-3125
Tapered Quartz Injector with Ball Joint, 1.5mm	31-808-0851
Tapered Quartz Injector with Ball Joint, 2.0mm	31-808-0806
Tapered Quartz Injector with Ball Joint, 2.5mm	31-808-3463



These injectors are compatible with both D-Torch and standard torch. They are suitable for torch adaptor 31-808-2824.

## HF Resistant Injectors

Tapered Alumina Injector 2.0mm	31-807-0060
Sapphire Injector 2.0mm	31-808-2803



These injectors are compatible with both D-Torch and standard torch. They are suitable for torch adaptor 31-808-2825.

## Torch Adaptor

Cassette Mount Adaptor for Ball Joint Injector	31-808-2824
---	-------------

This adaptor is suitable for injectors with a ball joint.



## Torch Adaptor

PFA Cassette Mount Adaptor	31-808-2825
----------------------------	-------------

This adaptor is suitable for injectors without a ball joint.



## Cones

## Sampler Cones

Nickel Sampler	PE3011-Ni
Aluminium Sampler	PE3011-Al
Platinum Sampler	PE3013-Pt
Platinum Sampler (18mm)	PE3013A-Pt
Platinum Sampler Boron free	PE3013-Pt-BF



## Skimmer Cones

Nickel Skimmer	PE3012-Ni
Aluminium Skimmer	PE3012-Al
Platinum Skimmer	PE3014-Pt
Platinum Skimmer Boron free	PE3014-Pt-BF
Aluminium Hyper Skimmer	PE3015-Al
Nickel Hyper Skimmer	PE3015-Ni
Platinum Hyper Skimmer	PE3015-Pt/Ni

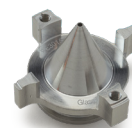

O-ring for NexION Hyper Skimmer Cone (pack of 5)	PE5115
---	--------



Screw for NexION Hyper Skimmer Cone (pack of 2)	PE5116
--	--------



## ConeGuard Thread Protectors

Sampler Cone Guard For NexION 300/350	70-803-1024
Skimmer Cone Guard For NexION 300/350	70-803-1026

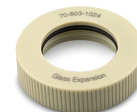

Gasket for Sampler Cone (pack of 5)	PE5111
--	--------



## RF Coils

Copper 70-900-2006C



RF Coil Installation Kit 70-900-2006T



## Common Accessories

### Elegra Argon Humidifier

Elegra Dual Argon Humidifier 70-803-1274



### Guardian In-Line Filters

Guardian DC in-line non-return gas filter 70-803-1942

Guardian in-line sample filter 70-803-1108

Eluo Adaptor for Inline Filter 70-803-1160



### Trident Internal Standard Kits

Trident CT Standard Kit 60-703-1179

Standard Kit for HF solutions 60-808-1150

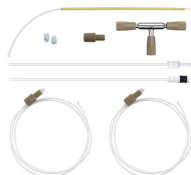

Magnifier Inspection Tool 70-803-1923



## Autosampler Probes (See page 20-21 for complete list of probes)

### Suitable for Cetac ASX-200/500/800 Series and PerkinElmer S20 Series

Guardian Probe 0.75mm  
Probe Connecting Line (Red) 70-803-1803

\*(suitable for Cetac only)



Guardian Probe with Holder, 0.75mm  
Probe Connecting Line (Red) 70-803-2097

\*(suitable for PerkinElmer S20 Series only)



Polyimide sheathed Autosampler  
Probe 0.5mm ID 60-808-1186L

PTFE Encapsulated Carbon Fibre  
Probe 0.5mm ID 70-803-0784

PTFE Encapsulated Carbon Fibre  
Probe 0.75mm ID 70-803-1443

PTFE Encapsulated Carbon Fibre  
Probe 1.0mm ID 70-803-0793



### Suitable for PE S10 or AS93+

PTFE Encapsulated Carbon  
Fibre Probe 0.25mm ID 70-803-1071

PTFE Encapsulated Carbon  
Fibre Probe 0.5mm ID 70-803-1440

PTFE Encapsulated Carbon  
Fibre Probe 1.0mm ID 70-803-0816



### Glass DC Nebulizers

#### SeaSpray

2mL/min uptake	A21-07-USS2
400µL/min uptake	A21-07-USS04

#### MicroMist

600µL/min uptake	A21-07-UM06
200µL/min uptake	A21-07-UM02
100µL/min uptake	A21-07-UM01
50µL/min uptake	A21-07-UM005



#### Slurry

4mL/min uptake	A21-07-US6
----------------	------------

#### Conikal

2mL/min uptake	A21-07-UC2
1mL/min uptake	A21-07-UC1

### DC Nebulizers for HF

#### DuraMist

1mL/min uptake	A21-07-DM1
400µL/min uptake	A21-07-DM04



#### OpalMist

2mL/min uptake	A21-07-PFA2
600µL/min uptake	A21-07-PFA06
200µL/min uptake	A21-07-PFA02
100µL/min uptake	A21-07-PFA01
50µL/min uptake	A21-07-PFA005



#### VeeSpray

0.6-3mL/min uptake	A21-07-CV6
--------------------	------------



### IsoMist XR

#### Programmable Temperature Cyclonic Spray Chamber

IsoMist XR Kit	KT-1147-XR
----------------	------------

#### Comprises:

Glass Twister Spray Chamber Assembly (LOL)	21-809-4347
PuraFlex Transfer Tube	20-809-5175
Metal Ball Joint Clip	21-809-4350
UniFit Right Angle Connector (PKT 3)	JC-13
	GAZ-04-90



### Spray Chambers

#### Twister

50mL Cyclonic	20-809-0495HE
---------------	---------------



#### Tracey

50mL Cyclonic	20-808-8882HE
---------------	---------------



#### Cinnabar

20mL Cyclonic	20-809-0164HE
---------------	---------------



#### Twinnabar

20mL Cyclonic	20-809-0498HE
---------------	---------------



#### HydraMist Simultaneous Cold Vapor/ Pneumatic Nebulization Spray Chamber

Hydride Kit	KT-1157
Hydride Kit for Avio with HTS system	KT-2742



### Spray Chambers for HF

#### Twister TFE

50mL Cyclonic	20-809-3452
---------------	-------------



#### Tracey TFE

50mL Cyclonic	20-809-2507
---------------	-------------



## Torches

### D-Torch for Avio 200

D-Torch 30-808-3800



#### Comprises:

Base and Inner Tube 31-808-3802

Quartz Outer Tube 31-808-3792

Retaining Ring 31-808-2818

#### D-Torch Options:

Ceramic Outer Tube 31-808-3820

Injector Adapter 31-808-3782

Viton O-Rings (Pkt 10) 70-803-1576



### D-Torch for Avio 500

D-Torch 30-808-3882



#### Comprises:

Base and Inner Tube 31-808-3883

Quartz Outer Tube 31-808-3792

Retaining Ring 31-808-2818

#### D-Torch Options:

Ceramic Outer Tube 31-808-3894

Injector Adapter 31-808-3782

Viton O-Rings (Pkt 10) 70-803-1576



### Tapered Injectors for D-Torch

Quartz Injector 0.8mm 31-808-3785

Quartz Injector 1.2mm 31-808-3786

Quartz Injector 1.6mm 31-808-3788

Quartz Injector 2.0mm 31-808-3789

Alumina Injector 1.25mm 31-808-3799

Alumina Injector 2.0mm 31-808-3783



### Capillary Injectors for D-Torch

Sapphire Injector 1.5mm 31-808-4296

Sapphire Injector 2.0mm 31-808-3784

### Fixed Torch for Avio 200/500

Quartz Torch with single slot 31-808-3776

Quartz Torch with 3 slots 31-808-4233



### Purge Windows for Avio 500

Optical Kit 70-803-1634

Radial Purge Extension 70-803-2033

Axial Purge Window 31-808-2649

Optical Oring Kit 70-803-2802

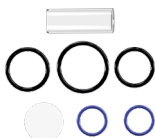

## Common Accessories

### Elegra Argon Humidifier

Elegra Argon Humidifier 70-803-1269



### Guardian In-Line Filters

Guardian DC in-line non-return gas filter 70-803-1942

Guardian in-line sample filter 70-803-1108

Eluo Adaptor for Inline Filter 70-803-1160



### Trident Internal Standard Kits

Trident CT Standard Kit 60-703-1179

Standard Kit for HF 60-808-1150

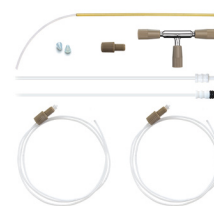

### Magnifier Inspection Tool 70-803-1923



## Autosampler Probes (See page 20-21 for complete list of probes)

### Suitable for Cetac ASX-200/500/800 Series

Guardian Probe 0.75mm Probe Connecting Line (Red) 70-803-1803

Polyimide sheathed Autosampler Probe 0.5mm ID 60-808-1186L

PTFE Encapsulated Carbon Fibre Probe 0.5mm ID 70-803-0784

PTFE Encapsulated Carbon Fibre Probe 0.75mm ID 70-803-1443

PTFE Encapsulated Carbon Fibre Probe 1.0mm ID 70-803-0793



### Suitable for PE S10 or AS93+

PTFE Encapsulated Carbon Fibre Probe 0.25mm ID 70-803-1071

PTFE Encapsulated Carbon Fibre Probe 0.5mm ID 70-803-1440

PTFE Encapsulated Carbon Fibre Probe 1.0mm ID 70-803-0816



### Glass DC Nebulizers

#### SeaSpray

2mL/min uptake	A21-07-USS2
400µL/min uptake	A21-07-USS04

#### MicroMist

600µL/min uptake	A21-07-UM06
200µL/min uptake	A21-07-UM02
100µL/min uptake	A21-07-UM01
50µL/min uptake	A21-07-UM005



#### Conikal

2mL/min uptake	A21-07-UC2
1mL/min uptake	A21-07-UC1

#### Slurry

4mL/min uptake	A21-07-US6
----------------	------------

### DC Nebulizers for HF

#### DuraMist

1mL/min uptake	A21-07-DM1
400µL/min uptake	A21-07-DM04



#### OpalMist

2mL/min uptake	A21-07-PFA2
600µL/min uptake	A21-07-PFA06
200µL/min uptake	A21-07-PFA02
100µL/min uptake	A21-07-PFA01
50µL/min uptake	A21-07-PFA005



#### VeeSpray

0.6 - 3mL/min uptake	A21-07-CV6
----------------------	------------



### IsoMist XR

#### Programmable Temperature Cyclonic Spray Chamber

IsoMist XR Kit	KT-1012-XR
----------------	------------

#### Comprises:

Glass Twister Spray Chamber Assembly (LOL)	21-809-3185
IsoMist Mount	21-809-2773
Adaptor GAZ08-12 90deg	21-809-2871
Clamping Screw	21-808-0953
UniFit Right Angle Connector (PKT 3)	GAZ-04-90



### Spray Chambers

#### Tracey

50mL Cyclonic	20-809-0434HE
---------------	---------------



#### Twister

50mL Cyclonic (Aqueous)	20-809-0208HE
With 7mm baffle	



#### Twister

50mL Cyclonic (Organics)	20-809-0446HE
With 4mm baffle	



#### Twister

50mL Cyclonic (Aux. Port)	20-809-0004HE
---------------------------	---------------



#### Cinnabar

20mL Cyclonic	20-809-9121HE
---------------	---------------



#### HydraMist Simultaneous Cold Vapor/ Pneumatic Nebulization Spray Chamber

HydraMist Kit	KT-1162
---------------	---------



### Spray Chambers for HF

#### Tracey TFE

50mL Cyclonic	20-809-2510
Plugs directly into cassette mount	



## Torches

**D-Torch** 30-808-3300 

**Comprises:**

Base and Inner Tube 31-808-3292

Quartz Outer Tube 31-808-3294

Retaining Ring 31-808-2818

**D-Torch Options**

Ceramic Outer Tube 31-808-2990 

Copper Foils (PKT 12) for Ceramic Outer Tube 31-808-3356

O-Ring Kit 70-803-0762

**Quartz Torch**

Without slots 31-808-3254 

With single slot 31-808-3255

With 3 slots 31-808-3256

**Quartz Torch Options:**

Copper Foil for Quartz Torch or D-Torch Quartz Outer Tube (pack of 12) 31-808-3289

**Tapered Quartz Injectors**

Quartz Injector 0.8mm 31-808-3257 

Quartz Injector 2.0mm 31-808-3258

Alumina Injector 1.2mm 31-808-3287

Alumina Injector 2.0mm 31-808-3286 

**Sapphire Injectors**

Sapphire Injector 2mm 31-808-3528

**Purge Windows**

Axial 17mm disk 31-808-0551 

Axial 32mm disk 31-808-2649

Radial (Post Nov. 2004) 31-808-2788

## Common Accessories

**Elegra Argon Humidifier**

Elegra Argon Humidifier 70-803-1269 

**Guardian In-Line Filters**

Guardian DC in-line non-return gas filter 70-803-1942 

Guardian in-line sample filter 70-803-1108

Eluo Adaptor for In-line Filter 70-803-1160

**Trident Internal Standard Kits**

Trident CT Standard Kit 60-703-1179 

Standard Kit for HF solutions 60-808-1150 

**Magnifier Inspection Tool** 70-803-1923 

**Autosampler Probes** (See page 20-21 for complete list of probes)

**Suitable for Cetac ASX-200/500/800 Series**

Guardian Probe 0.75mm Probe Connecting Line (Red) 70-803-1803 

Polyimide sheathed Autosampler Probe 0.5mm ID 60-808-1186L

PTFE Encapsulated Carbon Fibre Probe 0.5mm ID 70-803-0784

PTFE Encapsulated Carbon Fibre Probe 0.75mm ID 70-803-1443

PTFE Encapsulated Carbon Fibre Probe 1.0mm ID 70-803-0793

**Suitable for PE S10 or AS93+**

PTFE Encapsulated Carbon Fibre Probe 0.25mm ID 70-803-1071 

PTFE Encapsulated Carbon Fibre Probe 0.5mm ID 70-803-1440

PTFE Encapsulated Carbon Fibre Probe 1.0mm ID 70-803-0816

### Glass DC Nebulizers

<b>Conikal</b>	
1mL/min uptake	A41-1-UC1S
<b>SeaSpray</b>	
400µL/min uptake	A41-07-USS04S
<b>Slurry</b>	
4mL/min uptake	A41-1-US6
<b>MicroMist</b>	
600µL/min uptake	A41-07-UM06S
400µL/min uptake	A41-07-UM04
200µL/min uptake	A41-07-UM02
100µL/min uptake	A41-07-UM01
50µL/min uptake	A41-07-UM005



### Spray Chambers

<b>Glass</b>	
50mL Cyclonic	20-809-5042
With B14 gravity drain	



<b>Quartz</b>	
50mL Cyclonic	20-809-5044
With B14 gravity drain	



### Quartz DC Nebulizers

<b>SeaSpray</b>	
1mL/min uptake	A41-1-QSS1



<b>Drain Device</b>	21-809-4197
---------------------	-------------



### DC Nebulizers Compatible with HF

<b>OpalMist</b>	
1mL/min uptake	A41-1-PFA1S
400µL/min uptake	A41-07-PFA04
200µL/min uptake	A41-07-PFA02
100µL/min uptake	A41-07-PFA01
50µL/min uptake	A41-07-PFA005



<b>DuraMist</b>	
1mL/min uptake	A41-1-DM1S
400µL/min uptake	A41-07-DM04S



<b>VeeSpray</b>	
0.6 - 3mL/min uptake	A41-1-CV6



<b>Extention Pipe</b>	
with Aux Gas Port	70-803-2134



<b>Dilution Gas Tube</b>	
800mm	70-803-1766



### Spray Chambers Compatible with HF

<b>PFA</b>	
50mL Cyclonic	20-809-5043



<b>HF Drain Device</b>	21-809-2540
------------------------	-------------

<b>Extention Pipe</b>	
with Aux Gas Port	21-809-4857



## Torches

### Quartz Mini Torches

Torch with 1.5mm Injector	30-808-4258
Torch with 1.8mm Injector	30-808-4265

### Demountable Torch for HF

Mini Torch Kit	30-808-4282
----------------	-------------

#### Comprises:

Quartz Torch Body	31-808-4283
Alumina Injector 1.5mm	31-808-0774
Injector Holder	31-808-4129



## Cones

### Sampler Cones

Nickel Sampler	SZ7011-NiP
----------------	------------



Platinum Sampler	SZ7013-PtP
------------------	------------



Gasket for Sampler Cone (PKT 3)	SZ5001
---------------------------------	--------

Screw Kit for Sampler Cone (PKT 4)	SZ5004
------------------------------------	--------



### Skimmer Cones

Copper Skimmer	SZ7002-Cu
----------------	-----------



Nickel Skimmer Small	SZ7022-Ni
----------------------	-----------

Spacer for Skimmer Small	SZ5005
--------------------------	--------

Platinum Skimmer	SZ7004-Pt/Cu
------------------	--------------



Screw Kit for Skimmer Cone (PKT 2)	SZ5002
------------------------------------	--------

Cone Extraction Tool	70-803-1573
----------------------	-------------



## Common Accessories

### Elegra Argon Humidifier

Elegra Argon Humidifier	70-803-1312
Elegra Dual-Channel Argon Humidifier	70-803-1473
Dilution Gas Tube	70-803-2764



### Guardian In-Line Filters

Guardian DC in-line non-return gas filter	70-803-1942
Guardian in-line sample filter	70-803-1108
Eluo Adaptor for Inline Filter	70-803-1160



### Trident Internal Standard Kits

Trident CT Standard Kit	60-703-1179
Standard Kit for HF	60-808-1150

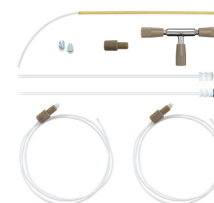

### Magnifier Inspection Tool 70-803-1923



## Autosampler Probes (See page 20-21 for complete list of probes)

### For Shimadzu AS10

PTFE Sheathed Carbon Fibre Probe 0.75mm ID with UniFit	70-803-1477
---	-------------





## Glass DC Nebulizers

### Conikal

1mL/min uptake      A41-1-UC1S

### SeaSpray

400µL/min uptake      A41-07-USS04S

### Slurry

4mL/min uptake      A41-1-US6

### MicroMist

600µL/min uptake      A41-07-UM06S

200µL/min uptake      A41-07-UM02

100µL/min uptake      A41-07-UM01

50µL/min uptake      A41-07-UM005



## Quartz DC Nebulizers

### SeaSpray

1mL/min uptake      A41-1-QSS1



## DC Nebulizers Compatible with HF

### OpalMist

1mL/min uptake      A41-1-PFA1S

400µL/min uptake      A41-07-PFA04

200µL/min uptake      A41-07-PFA02

100µL/min uptake      A41-07-PFA01

50µL/min uptake      A41-07-PFA005



### DuraMist

1mL/min uptake      A41-1-DM1S

400µL/min uptake      A41-07-DM04S



### VeeSpray

0.6 - 3mL/min uptake      A41-1-CV6



## Spray Chambers

### Glass

50mL Cyclonic      21-809-3994

With B14 gravity drain



### Quartz

50mL Cyclonic      21-809-3992

With B14 gravity drain



### Drain Device

21-808-8214



### Extention Pipe

Quartz Transfer Tube      31-808-3920



## Spray Chambers Compatible with HF

### PFA

50mL Cyclonic      21-809-3991



### HF Drain Device

21-809-2540



### Extention Pipe

PFA Extention w/ right angle      21-809-4081



## Torches

### Quartz Torches

Quartz Mini Torch 30-807-0567  
(Suitable for ICP-MS 2030)

Torch with 1.2mm Injector 30-808-9986  
(Suitable for ICP-MS 8500)

Quartz Sleeve for Mini Torch 31-808-4214  
(Suitable for ICP-MS 2030)

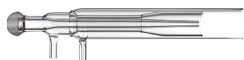

### Demountable Torch for HF

Mini Torch Kit 30-808-4401

#### Comprises:

Quartz Torch Body 31-808-4283

Alumina Injector 1.2mm 31-808-4353

Injector Holder 31-808-4129



## RF Coils

Copper 70-900-6000C



Silver 70-900-6000S



Gold 70-900-6000G



### RF Coil Installation Kit

RF Coil Installation Kit 70-900-6000T



## Cones

### Sampler Cones

Copper Sampler SZ7001-Cu



Nickel Sampler SZ7001-Ni



Nickel Sampler with Copper Base SZ7001-Ni/Cu

Platinum Sampler (10mm Insert) SZ7003-Pt/Cu



Gasket for Sampler Cone (PKT 3) SZ5001

Screw Kit for Sampler Cone (PKT 4) SZ5004



O-Ring Kit 70-803-1908



### Skimmer Cones

Copper Skimmer SZ7002-Cu



Nickel Skimmer SZ7002-Ni



Nickel Skimmer with Copper Base SZ7002-Ni/Cu



Platinum Skimmer SZ7004-Pt/Cu

Screw Kit for Skimmer Cone (PKT 2) SZ5002



Cone Extraction Tool 70-803-1573

## Common Accessories

### Elegra Argon Humidifier

Elegra Argon Humidifier 70-803-1312



### Guardian In-Line Filters

Guardian DC in-line non-return gas filter 70-803-1942

Guardian in-line sample filter 70-803-1108

Eluo Adaptor for Inline Filter 70-803-1160



### Trident Internal Standard Kits

Trident CT Standard Kit 60-703-1179

Standard Kit for HF 60-808-1150

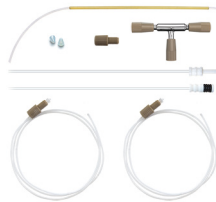

**Magnifier Inspection Tool** 70-803-1923



## Autosampler Probes (See page 20-21 for complete list of probes)

### For Shimadzu AS10

PTFE Sheathed Carbon Fibre Probe  
0.75mm ID with UniFit 70-803-1477



## Glass DC Nebulizers

**Conikal**  
1mL/min uptake                      A41-1-UC1S

**SeaSpray**  
2mL/min uptake                      A41-1-USS2S

**Slurry**  
4mL/min uptake                      A41-1-US6

**MicroMist**  
600µL/min uptake                      A41-07-UM06S  
200µL/min uptake                      A41-07-UM02  
100µL/min uptake                      A41-07-UM01  
50µL/min uptake                      A41-07-UM005



## DC Nebulizers for HF

**OpalMist**  
1mL/min uptake                      A41-1-PFA1S  
600µL/min uptake                      A41-07-PFA06S  
200µL/min uptake                      A41-07-PFA02  
100µL/min uptake                      A41-07-PFA01  
50µL/min uptake                      A41-07-PFA005



**DuraMist**  
1mL/min uptake                      A41-1-DM1S  
400µL/min uptake                      A41-07-DM04S



**VeeSpray**  
0.6 - 3mL/min uptake                      A41-1-CV6



## IsoMist XR

**Programmable Temperature Cyclonic Spray Chamber**

IsoMist XR Kit                      KT-1067-XR

**Comprises:**

Glass Twister Spray Chamber With B14 drain                      21-809-3270  
Assembly B14 (LOL)                      20-809-5187  
Adaptor                      21-809-3998  
Adjustable Stand                      70-803-2798  
Metal Ball Joint Clip                      JC-13  
Drain Device                      21-808-8214



## IsoMist XR

**Programmable Temperature Cyclonic Spray Chamber**

IsoMist XR Kit                      KT-2749-XR

Requires peristaltic pump

**Comprises:**

Glass Twister Spray Chamber                      21-809-3186  
Assembly (ROL)                      20-809-5176  
Adaptor                      21-809-3998  
Adjustable Stand                      21-809-4911  
Metal Ball Joint Clip                      JC-13  
UniFit Drain (PKT 3)                      UFT-16-75



## Spray Chambers

**Tracey**  
50mL Cyclonic                      20-808-8881HE  
With B14 gravity drain



**Twister**  
50mL Cyclonic                      20-809-9119HE  
With B14 gravity drain



**Twister**  
50mL Cyclonic                      20-809-0222HE



**Cinnabar**  
20mL Cyclonic                      20-809-0164HE



**HydraMist Simultaneous Cold Vapor/ Pneumatic Nebulization Spray Chamber**

Hydride Kit                      KT-1157



**Spray Chambers**

(continued)

**Drain Device** 21-808-8214



**Transfer Tube, Spray Chamber to ICPE-9000/9800 Torch**

Glass Transfer Tube 86mm 21-809-2846



**Spray Chambers for HF**

**Tracey TFE**

50mL Cyclonic 20-809-2508

With B14 gravity drain  
Suitable for use with HF



**HF Drain Device** 21-809-2540



**Mounting bracket for HF Spray Chamber**

21-809-2839



**Transfer Tube, Spray Chamber to ICPE-9000/9800 Torch**

PFA Transfer Tube 82.5mm 31-808-3071



**Torches**

**Semi Demountable Torch (HF)**

30-808-4335

Suitable for ICPS-7500/8100 and ICPE-9000/9800

**Comprises:**

Torch Body 31-808-4341

Injector Adaptor 31-808-4129

Tapered Alumina Injector 1.5mm 31-808-3202

**Torch Options:**

Tapered Quartz Injector 1.0mm 31-808-3423

Tapered Quartz Injector 1.8mm 31-808-4005

Tapered Quartz Injector 2.0mm 31-808-4006

Tapered Quartz Injector 2.5mm 31-808-3302

Tapered Alumina Injector 2.4mm 31-808-3205

Sapphire Injector 2.0mm 31-808-3378

Viton O-rings for FDT/SDT ball joints (PKT 10) 70-V-011

GazFit Connectors (PKT 4) for 4mm OD side arms GAZ-04

**Quartz Torches**

Quartz Torch Standard 1.5mm Injector (Suitable for 7500/8100) 30-808-1179

Quartz Torch for Organics, 1.0mm Injector (Suitable for 7500/8100/9000/9800) 30-807-0519

Quartz Torch for High TDS, 1.8mm Injector (Suitable for 7500/8100/9000/9800) 30-807-0518

Quartz Torch for High TDS, 2.0mm Injector (Suitable for 7500/8100/9000/9800) 30-807-0564

Quartz Mini Torch 1.5mm Injector (Suitable for ICPE-9000/9800) 30-807-0534

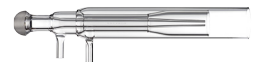

## RF Coils

Copper	70-900-6100C
Silver	70-900-6100S
Gold	70-900-6100G



**RF Coil Installation Kit** 70-900-6100T



## Autosampler Probes (See page 20-21 for complete list of probes)

### For Shimadzu AS10

PTFE Coated Vitcon O-rings  
(PKT 10) With UniFit 70-803-1477



## Common Accessories

### Elegra Argon Humidifier

Elegra Argon Humidifier 70-803-1312



### Guardian In-Line Filters

Guardian DC in-line non-return gas filter	70-803-1942
Guardian in-line sample filter	70-803-1108
Eluo Adaptor for Inline Filter	70-803-1160



### Trident Internal Standard Kits

Trident CT Standard Kit	60-703-1179
Standard Kit for HF	60-808-1150

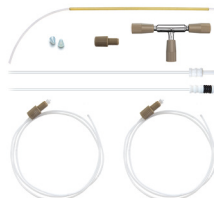

**Magnifier Inspection Tool** 70-803-1923



## Glass DC Nebulizers

**SeaSpray**

2mL/min uptake      A21-1-USS2

**MicroMist**

400µL/min uptake      A21-1-UM04

**Slurry**

4mL/min uptake      A21-1-US6

**Conikal**

2mL/min uptake      A21-1-UC2



## Spray Chambers

**Tracey**

50mL Cyclonic      20-809-2665HE

**Twister**

50mL Cyclonic      20-809-2951HE

**Scott Spray Chamber**

20-809-4053

## DC Nebulizers for HF

**DuraMist**

1mL/min uptake      A21-1-DM1

400µL/min uptake      A21-1-DM04

**VeeSpray**

0.6-3mL/min uptake      A21-1-CV6

**HydraMist Simultaneous Cold Vapor/  
Pneumatic Nebulization Spray Chamber**

Hydride Kit      KT-1160

**Quartz Adaptor**

21-809-3772

**Quartz Adaptor with  
Aux Port**

21-809-3771



## IsoMist XR

**Programmable Temperature Cyclonic  
Spray Chamber**

IsoMist XR Kit      KT-1141-XR

**Comprises:**

Glass Twister Spray Chamber      21-809-3185

Assembly (LOL)      20-809-5175

Adaptor 12/8 for SpectroBlue      31-808-3489

Glass Ball Cup Adaptor S19      21-809-4101

Tygon Tubing 1/4 inch x 1m      1921-1M

Metal Ball Joint Clip      JC-19

GazFit Connectors for 8mm  
OD arm (PKT 2)      GAZ-08UniFit Right Angle Connector  
(PKT 3)      GAZ-04-90

## Spray Chambers for HF

**Tracey TFE**

50mL Cyclonic      20-809-3717

Suitable for use with HF.  
Requires Transfer Tube 21-809-3726.**PuraFlex Transfer Tube**      21-809-3726

## Torches

**D-Torch Blue EOP** 30-808-3600  
**D-Torch Blue TI** 30-808-3629

**Comprises:**

Base and Inner Tube 31-808-3605  
 Quartz Outer Tube 31-808-3630  
 Injector Ferrule 31-808-2962  
 Retaining Ring 31-808-3595  
 Adaptor for D-Torch B19 31-808-3651  
 Adaptor S19-B19-90deg 21-809-4045  
 Metal Ball Joint Clip JC-19

**D-Torch Options:**

Sheath Gas Adaptor 21-809-4082  
 Aux Gas Line 70-803-1424



**Tapered Injectors for Blue EOP/TI**

**D-Torch**

Quartz Injector 1.0mm 31-808-0009  
 Quartz Injector 1.2mm 31-808-3643  
 Quartz Injector 1.5mm 31-808-0007  
 Quartz Injector 1.8mm 31-808-8146  
 Quartz Injector 2.0mm 31-808-0008  
 Quartz Injector 2.4mm 31-808-3541  
 Quartz Injector 2.5mm 31-808-3645  
 Alumina Injector 1.0mm 31-808-0835  
 Alumina Injector 1.5mm 31-808-0013  
 Alumina Injector 1.8mm 31-808-0015  
 Alumina Injector 2.0mm 31-808-0027



**Capillary Injectors for Blue EOP/TI**

**D-Torch**

Alumina Injector 1.8mm 31-808-0087



## Torches

(continued)

**D-Torch ARCOS II EOP** 30-808-3657

**Comprises:**

Base and Inner Tube 31-808-3660  
 Quartz Outer Tube 31-808-3658  
 Injector Ferrule 31-808-2962  
 Retaining Ring 31-808-3595  
 Adaptor for D-Torch B19 31-808-3651  
 Adaptor S19-B19-90deg 21-809-4045  
 Metal Ball Joint Clip JC-19

**D-Torch Options:**

Sheath Gas Adaptor 21-809-4082  
 Adaptor S19-B13-90deg 21-809-4048



**Tapered Injectors for ARCOS II EOP**

**D-Torch**

Quartz Injector 2.5mm 31-808-3676  
 Alumina Injector 2.0mm 31-808-3699  
 Alumina Injector 2.4mm 31-808-3700



**Capillary Injectors for ARCOS II EOP**

**D-Torch**

Sapphire Injector 2.0mm 31-808-3718  
 Sapphire Injector 2.4mm 31-808-3850



**Quartz Torch**

SpectroBlue EOP 31-808-3394  
 SpectroBlue TI 31-808-3468



**Injectors for Quartz Torch**

Quartz Injector 1.2mm 31-808-3410  
 Quartz Injector 1.8mm 31-808-3391  
 Quartz Injector 2.0mm 31-808-3411  
 Quartz Injector 3.0mm 31-808-3412  
 Alumina Injector 1.8mm 31-808-3409  
 Alumina Injector 2.5mm 31-808-3390





## Common Accessories

### Elegra Argon Humidifier

Elegra Argon Humidifier	70-803-1269
Elegra Stand	70-803-1581



### Guardian In-Line Filters

Guardian DC in-line non-return gas filter	70-803-1942
Guardian in-line sample filter	70-803-1108
Eluo Adaptor for Inline Filter	70-803-1160



### Trident Internal Standard Kits

Trident CT Standard Kit	60-703-1179
Standard Kit for HF	60-808-1150

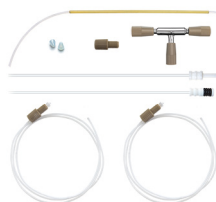

### Magnifier Inspection Tool 70-803-1923



## Autosampler Probes (See page 20-21 for complete list of probes)

### For Cetac ASX-200/500/800 Series

Guardian Probe 0.75mm	
Probe Connecting Line (Red)	70-803-1803
Polyimide sheathed Autosampler Probe	
0.5mm ID	60-808-1186L
PTFE Encapsulated Carbon Fibre Probe	
0.5mm ID	70-803-0784
PTFE Encapsulated Carbon Fibre Probe	
0.75mm ID	70-803-1443
PTFE Encapsulated Carbon Fibre Probe	
1.0mm ID	70-803-0793



## Glass DC Nebulizers

### SeaSpray

2mL/min uptake      A21-1-USS2

### MicroMist

400µL/min uptake      A21-1-UM04

### Slurry

4mL/min uptake      A21-1-US6

### Conikal

2mL/min uptake      A21-1-UC2



## DC Nebulizers for HF

### DuraMist

1mL/min uptake      A21-1-DM1

400µL/min uptake      A21-1-DM04

### VeeSpray

0.6-3mL/min uptake      A21-1-CV6



## IsoMist XR

### Programmable Temperature Cyclonic Spray Chamber

IsoMist XR Kit      KT-1141-XR

#### Comprises:

Glass Twister Spray Chamber      21-809-3185

Assembly (LOL)      20-809-5175

Adaptor 12/8 for SpectroBlue      31-808-3489

Glass Ball Cup Adaptor S19      21-809-4101

Tygon Tubing 1/4 inch x 1m      1921-1M

Metal Ball Joint Clip      JC-19

GazFit Connectors for 8mm      GAZ-08

OD arm (PKT 2)

UniFit Right Angle Connector      GAZ-04-90

(PKT 3)



## Spray Chambers

### Tracey

50mL Cyclonic      20-809-2665HE



### Twister

50mL Cyclonic      20-809-2951HE



### HydraMist Simultaneous Cold Vapor/Pneumatic Nebulization Spray Chamber

Hydride Kit      KT-1160



**Straight Quartz Adaptor**      21-809-3773



**Straight Quartz Adaptor with Aux Port**      21-809-3804



**Sheath Gas Adaptor**      21-809-4083



## Spray Chambers for HF

### Tracey TFE

50mL Cyclonic      20-809-3717

Suitable for use with HF.      21-809-3727

Requires Transfer Tube



**Straight HF Resistant Adaptor**      21-809-3727



**Torches**

**Quartz Torch**

SpectroBlue SOP 31-808-3405



**Injectors for Quartz Torch**

Quartz Injector 1.0mm 31-808-4148

Quartz Injector 1.2mm 31-808-3410

Quartz Injector 1.5mm 31-808-4234

Quartz Injector 1.8mm 31-808-3391

Quartz Injector 2.0mm 31-808-3411

Quartz Injector 2.5mm 31-808-4235

Quartz Injector 3.0mm 31-808-3412

Alumina Injector 1.8mm 31-808-3409

Alumina Injector 2.5mm 31-808-3390



**Fixed Quartz Torch**

Quartz Torch 1.8mm injector S19, SOP 30-808-4264



**Fixed Quartz Torch**

Quartz Torch 2.0mm injector S19, SOP 30-808-4403



**Common Accessories**

**Elegra Argon Humidifier**

Elegra Argon Humidifier 70-803-1269



Elegra Stand 70-803-1581



**Guardian In-Line Filters**

Guardian DC in-line non-return gas filter 70-803-1942

Guardian in-line sample filter 70-803-1108

Eluo Adaptor for Inline Filter 70-803-1160



**Common Accessories**

(continued)

**Trident Internal Standard Kits**

Trident CT Standard Kit 60-703-1179

Standard Kit for HF 60-808-1150

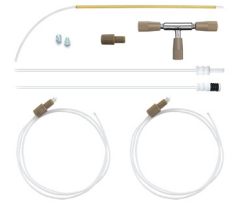

**Magnifier Inspection Tool** 70-803-1923



**Autosampler Probes** (See page 20-21 for complete list of probes)

**For Cetac ASX-200/500/800 Series**

Guardian Probe 0.75mm

Probe Connecting Line (Red) 70-803-1803

Polyimide sheathed Autosampler Probe 0.5mm ID 60-808-1186L

PTFE Encapsulated Carbon Fibre Probe 0.5mm ID 70-803-0784

PTFE Encapsulated Carbon Fibre Probe 0.75mm ID 70-803-1443

PTFE Encapsulated Carbon Fibre Probe 1.0mm ID 70-803-0793



## Glass DC Nebulizers

### SeaSpray

400µL/min uptake      A31-1-USS04

### MicroMist

400µL/min uptake      A31-1-UM04

200µL/min uptake      A31-1-UM02

100µL/min uptake      A31-1-UM01

50µL/min uptake      A31-1-UM005



## Quartz DC Nebulizers

### SeaSpray

1mL/min uptake      A31-1-QSS1



## DC Nebulizers for HF

### OpalMist

400µL/min uptake      A31-1-PFA04

200µL/min uptake      A31-1-PFA02

100µL/min uptake      A31-1-PFA01Q

50µL/min uptake      A31-1-PFA005Q



## DC Nebulizers for HE-SIS

### MicroMist HE

200µL/min uptake      C13-1-UFT02

200µL/min uptake      E13-1-UFT02



## Spray Chambers

### High Efficiency Sample Introduction System

HE-SIS for Thermo Q/RQ/TQ ICP-MS      KT-1172



## Torches

### Quartz Torch

Base for Q Torch      31-808-3494



Quartz Tube Set      31-808-3357



### Ceramic Torch

Ceramic Outer Tube Set      31-808-4048



### Torch Options:

Quartz Injector 1.0mm      31-808-3440

Quartz Injector 2.0mm      31-808-3898

Quartz Injector 2.5mm      31-808-3428

Sapphire Injector 2.0mm      31-808-4014

Tapered Alumina Injector 2.0mm      31-808-4012

O-ring Kit for Q Torch base (31-808-3494)      70-803-1535



## Cones

### Sampler Cones

Nickel Sampler with Copper Core	TG1021-Ni/Cu
Aluminium Sampler	TG1021-Al
Platinum Sampler with Copper Core	TG1026A-Pt/Cu



### Skimmer Cones

Nickel Skimmer Hot and Cold Plasma	TG1035-Ni
Platinum Skimmer Hot and Cold Plasma	TG1039-Pt
Nickel Skimmer (Robust Plasma)	TG1045-Ni
Eliminates need for insert.	
Nickel Skimmer (High Matrix)	TG1044-Ni
Eliminates need for insert.	
Platinum Skimmer (High Matrix)	TG1048-Pt
Eliminates need for insert.	
Cone Extraction Tool	70-803-2050
Skimmer Cone Guard	70-803-1028
Graphite Sampler Cone Gasket	TG5001



## Common Accessories

### Elegra Argon Humidifier

Elegra Argon Humidifier 70-803-1268



### Guardian In-Line Filters

Guardian DC in-line non-return gas filter 70-803-1942  
 Guardian in-line sample filter 70-803-1108  
 Eluo Adaptor for Inline Filter 70-803-1160



### Trident Internal Standard Kits

Trident CT Standard Kit 60-703-1179  
 Standard Kit for HF 60-808-1150

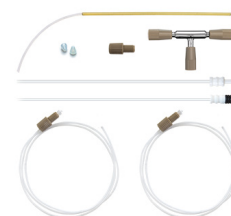

### Magnifier Inspection Tool 70-803-1923



## Autosampler Probes (See page 20-21 for complete list of probes)

### For Cetac ASX-200/500/800 Series

Guardian Probe 0.75mm  
 Probe Connecting Line (Red) 70-803-1803  
 Polyimide sheathed Autosampler Probe 0.5mm ID 60-808-1186L  
 PTFE Encapsulated Carbon Fibre Probe 0.5mm ID 70-803-0784  
 PTFE Encapsulated Carbon Fibre Probe 0.75mm ID 70-803-1443  
 PTFE Encapsulated Carbon Fibre Probe 1.0mm ID 70-803-0793



### Glass DC Nebulizers

#### SeaSpray

400µL/min uptake      A31-1-USS04

#### MicroMist

400µL/min uptake      A31-1-UM04

200µL/min uptake      A31-1-UM02

100µL/min uptake      A31-1-UM01

50µL/min uptake      A31-1-UM005



### Quartz DC Nebulizers

#### SeaSpray

1mL/min uptake      A31-1-QSS1



### DC Nebulizers for HF

#### OpalMist

400µL/min uptake      A31-1-PFA04

200µL/min uptake      A31-1-PFA02

100µL/min uptake      A31-1-PFA01Q

50µL/min uptake      A31-1-PFA005Q



### DC Nebulizers for HE-SIS

#### MicroMist HE

200µL/min uptake      C13-1-UFT02

200µL/min uptake      E13-1-UFT02



### Spray Chambers

#### High Efficiency Sample Introduction System

HE-SIS for Thermo Neoma MC-ICP-MS      KT-1172



### Torches

#### Quartz Torch

Base for Q Torch      31-808-3494

Quartz Tube Set      31-808-3357

#### Ceramic Torch

Ceramic Tube Set      31-808-4048

#### Torch Options:

Quartz Injector 1.0mm      31-808-3440

Quartz Injector 2.0mm      31-808-3898

Quartz Injector 2.5mm      31-808-3428

Sapphire Injector 2.0mm      31-808-4014

Tapered Alumina Injector 2.0mm      31-808-4012

O-ring Kit for Q Torch base (31-808-3494)      70-803-1535



### Cones

#### Sampler Cones

Nickel Jet Sampler      TF1005-Ni

Nickel Sampler with Copper Core      TF1001-Ni/Cu

Platinum Sampler with Copper Core      TF1006-Pt/Cu



#### Skimmer Cones

Nickel Skimmer      TF1002A-Ni

Nickel X Skimmer with Copper Core      TF1002X-Ni

Platinum Skimmer (H, boron-free)      TF1008-Pt



#### Graphite Sampler Cone Gasket

TG5001



## Common Accessories

### Elegra Argon Humidifier

Elegra Argon Humidifier 70-803-1268



### Guardian In-Line Filters

Guardian DC in-line non-return gas filter 70-803-1942

Guardian in-line sample filter 70-803-1108

Eluo Adaptor for Inline Filter 70-803-1160



### Trident Internal Standard Kits

Trident CT Standard Kit 60-703-1179

Standard Kit for HF 60-808-1150



Magnifier Inspection Tool 70-803-1923



## Autosampler Probes (See page 20-21 for complete list of probes)

### For Cetac ASX-200/500/800 Series

Guardian Probe 0.75mm  
Probe Connecting Line (Red) 70-803-1803

Guardian Probe ASX-112FR 70-803-2029

Polyimide sheathed Autosampler  
Probe 0.5mm ID 60-808-1186L

PTFE Encapsulated Carbon  
Fibre Probe 0.5mm ID 70-803-0784

PTFE Encapsulated Carbon  
Fibre Probe 0.75mm ID 70-803-1443

PTFE Encapsulated Carbon  
Fibre Probe 1.0mm ID 70-803-0793

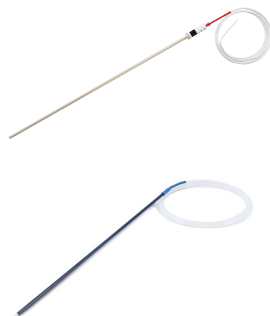

## Glass DC Nebulizers

### SeaSpray

2mL/min uptake	A31-07-USS2
400µL/min uptake	A31-07-USS04

### MicroMist

600µL/min uptake	A31-07-UM06
200µL/min uptake	A31-07-UM02
100µL/min uptake	A31-07-UM01
50µL/min uptake	A31-07-UM005



### Conikal

2mL/min uptake	A31-07-UC2
1mL/min uptake	A31-07-UC1

### Slurry

4mL/min uptake	A31-07-US6
----------------	------------

## DC Nebulizers for HF

### DuraMist

1mL/min uptake	A31-07-DM1
400µL/min uptake	A31-07-DM04



### OpalMist

2mL/min uptake	A31-07-PFA2
600µL/min uptake	A31-07-PFA06
200µL/min uptake	A31-07-PFA02
100µL/min uptake	A31-07-PFA01
50µL/min uptake	A31-07-PFA005



### VeeSpray

0.6 - 3mL/min uptake	A31-07-CV6
----------------------	------------



## IsoMist XR

### Programmable Temperature Cyclonic Spray Chamber

IsoMist XR Kit	KT-1166-XR
----------------	------------

#### Comprises:

Glass Twister Spray Chamber Assembly (LOL)	21-809-3185
PuraFlex Transfer Tube	20-809-5175
UniFit Right Angle Connector (PKT 3)	21-809-4426
	GAZ-04-90



## Spray Chambers

### Tracey

50mL Cyclonic	20-809-2665HE
---------------	---------------



### Twister

50mL Cyclonic	20-809-2951HE
---------------	---------------



### Straight Ball Joint Adaptor

21-809-2723
-------------



### Sheath Gas Adaptor

31-808-3891
-------------



### HydraMist Simultaneous Cold Vapor/ Pneumatic Nebulization Spray Chamber

Hydride Kit	KT-1160
-------------	---------



## Spray Chambers for HF

### Tracey TFE

50mL Cyclonic	20-809-9198
---------------	-------------





## Torches

**D-Torch** 30-808-4150 

**Comprises:**

Base and Inner Tube 31-808-4255

Quartz Outer Tube with slot 31-808-4152 

**D-Torch Options:**

Ceramic Outer Tube with slot 31-808-3996 

Retaining Ring 31-808-2707 

Injector Adaptor 31-808-2895

Injector Ferrule 31-808-2897

### D-Torch

**D-Torch Options:**

PTFE Coated  
Viton O-rings (PKT 10) VT-007 

O-ring kit for Thermo  
6000/7000/PRO D-Torch 70-803-1921 

O-ring and Seal kit for Thermo  
Torch & Windows 70-803-1550

### Quartz Torch

EMT Design 31-808-4158 

### Tapered Injectors for D-Torch & EMT Torch

Quartz Injector 0.75mm 31-808-3511 

Quartz Injector 1.0mm 31-808-2833

Quartz Injector 1.5mm 31-808-2834

### Capillary Injectors for D-Torch & EMT Torch

Quartz Injector 1.0mm 31-808-3510

Quartz Injector 2.0mm 31-808-2836 

Quartz Injector 2.5mm 31-808-3246

Quartz Injector 3.0mm 31-808-3247

Alumina Injector 1.0mm 31-808-3279 

Alumina Injector 2.0mm 31-808-2835

Sapphire Injector 2.0mm 31-808-2977

## RF Coils

### RF Coil for PRO

Silver 70-900-4006S 

Gold 70-900-4006G 

**RF Coil Installation Kit** 70-900-4002T 

## Common Accessories

### Elegra Argon Humidifier

Elegra Argon Humidifier 70-803-1268 

### Guardian In-Line Filters

Guardian DC in-line non-return  
gas filter 70-803-1942 

Guardian in-line sample filter 70-803-1108

Eluo Adaptor for Inline Filter 70-803-1160

### Trident Internal Standard Kits

Trident CT Standard Kit 60-703-1179 

Standard Kit for HF 60-808-1150 

**Magnifier Inspection Tool** 70-803-1923 

## Autosampler Probes (See page 20-21 for complete list of probes)

### For Cetac ASX-200/500/800 Series

Guardian Probe 0.75mm  
Probe Connecting Line (Red) 70-803-1803

Polyimide sheathed Autosampler  
Probe 0.5mm ID 60-808-1186L

PTFE Encapsulated Carbon  
Fibre Probe 0.5mm ID 70-803-0784

PTFE Encapsulated Carbon  
Fibre Probe 0.75mm ID 70-803-1443

PTFE Encapsulated Carbon  
Fibre Probe 1.0mm ID 70-803-0793



### Glass DC Nebulizers

#### SeaSpray

2mL/min uptake	A31-07-USS2
400µL/min uptake	A31-07-USS04

#### MicroMist

600µL/min uptake	A31-07-UM06
200µL/min uptake	A31-07-UM02
100µL/min uptake	A31-07-UM01
50µL/min uptake	A31-07-UM005



#### Conikal

2mL/min uptake	A31-07-UC2
1mL/min uptake	A31-07-UC1

#### Slurry

4mL/min uptake	A31-07-US6
----------------	------------

### DC Nebulizers for HF

#### DuraMist

1mL/min uptake	A31-07-DM1
400µL/min uptake	A31-07-DM04



#### OpalMist

2mL/min uptake	A31-07-PFA2
600µL/min uptake	A31-07-PFA06
200µL/min uptake	A31-07-PFA02
100µL/min uptake	A31-07-PFA01
50µL/min uptake	A31-07-PFA005



#### VeeSpray

0.6 - 3mL/min uptake	A31-07-CV6
----------------------	------------



### IsoMist XR

#### Programmable Temperature Cyclonic Spray Chamber

IsoMist XR Kit	KT-1166-XR
----------------	------------

#### Comprises:

Glass Twister Spray Chamber Assembly (LOL)	21-809-3185
PuraFlex Transfer Tube	21-809-4426
UniFit Right Angle Connector (PKT 3)	GAZ-04-90



### Spray Chambers

#### Tracey

50mL Cyclonic	20-809-2665HE
---------------	---------------



#### Twister

50mL Cyclonic	20-809-2951HE
---------------	---------------



#### Straight Ball Joint Adaptor

21-809-2723
-------------



#### Sheath Gas Adaptor

31-808-3891
-------------



#### HydraMist Simultaneous Cold Vapor/Pneumatic Nebulization Spray Chamber

Hydride Kit	KT-1160
-------------	---------



### Spray Chambers for HF

#### Tracey TFE

50mL Cyclonic	20-809-9198
---------------	-------------



## Torches

### D-Torch

30-808-2877

#### Comprises:

Base and Inner Tube 31-808-2932  
 Quartz Outer Tube 31-808-2878



#### D-Torch Options:

Ceramic Outer Tube 31-808-3836  
 PTFE Coated  
 Viton O-rings (PKT 10) VT-007  
 Viton O-rings (PKT 10) V-026  
 O-ring kit for Thermo 6000/7000/PRO D-Torch 70-803-1921  
 O-ring and Seal kit for Thermo Torch & Windows 70-803-1550  
 Retaining Ring 31-808-2707  
 Injector Adaptor 31-808-2895  
 Injector Ferrule 31-808-2897



### Quartz Torch

EMT Design 31-808-2810



### Tapered Injectors for D-Torch & EMT Torch

Quartz Injector 0.75mm 31-808-3511  
 Quartz Injector 1.0mm 31-808-2833  
 Quartz Injector 1.5mm 31-808-2834



### Capillary Injectors for D-Torch & EMT Torch

Quartz Injector 1.0mm 31-808-3510  
 Quartz Injector 2.0mm 31-808-2836  
 Quartz Injector 2.5mm 31-808-3246  
 Quartz Injector 3.0mm 31-808-3247  
 Alumina Injector 1.0mm 31-808-3279  
 Alumina Injector 2.0mm 31-808-2835  
 Sapphire Injector 2.0mm 31-808-2977



## RF Coils

### RF Coil for PRO

Silver 70-900-4006S  
 Gold 70-900-4006G



### RF Coil Installation Kit 70-900-4002T



## Common Accessories

### Elegra Argon Humidifier

Elegra Argon Humidifier 70-803-1268



### Guardian In-Line Filters

Guardian DC in-line non-return gas filter 70-803-1942  
 Guardian in-line sample filter 70-803-1108  
 Eluo Adaptor for Inline Filter 70-803-1160



### Trident Internal Standard Kits

Trident CT Standard Kit 60-703-1179  
 Standard Kit for HF 60-808-1150

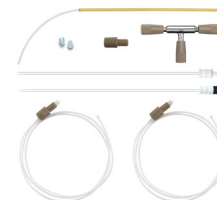

### Magnifier Inspection Tool 70-803-1923



**Autosampler Probes** (See page 20-21 for complete list of probes)**For Cetac ASX-200/500/800 Series**

Guardian Probe 0.75mm

Probe Connecting Line (Red) 70-803-1803

Polyimide sheathed Autosampler

Probe 0.5mm ID 60-808-1186L

PTFE Encapsulated Carbon

Fibre Probe 0.5mm ID 70-803-0784

PTFE Encapsulated Carbon

Fibre Probe 0.75mm ID 70-803-1443

PTFE Encapsulated Carbon

Fibre Probe 1.0mm ID 70-803-0793



### Glass DC Nebulizers

#### SeaSpray

2mL/min uptake	A31-07-USS2
400µL/min uptake	A31-07-USS04

#### MicroMist

600µL/min uptake	A31-07-UM06
200µL/min uptake	A31-07-UM02
100µL/min uptake	A31-07-UM01
50µL/min uptake	A31-07-UM005



#### Conikal

2mL/min uptake	A31-07-UC2
1mL/min uptake	A31-07-UC1

#### Slurry

4mL/min uptake	A31-07-US6
----------------	------------

### DC Nebulizers for HF

#### DuraMist

1mL/min uptake	A31-07-DM1
400µL/min uptake	A31-07-DM04



#### OpalMist

2mL/min uptake	A31-07-PFA2
600µL/min uptake	A31-07-PFA06
200µL/min uptake	A31-07-PFA02
100µL/min uptake	A31-07-PFA01
50µL/min uptake	A31-07-PFA005



#### VeeSpray

0.6 - 3mL/min uptake	A31-07-CV6
----------------------	------------



### IsoMist XR

#### Programmable Temperature Cyclonic Spray Chamber

IsoMist XR Kit	KT-1015-XR
----------------	------------

#### Comprises:

Glass Spray Chamber	21-809-3186
Assembly (ROL)	20-809-5176
PuraFlex Transfer Tube	21-809-3455
UniFit Right Angle Connector (PKT 3)	GAZ-04-90



### Spray Chambers

#### Tracey

50mL Cyclonic	20-809-2665HE
---------------	---------------



#### Twister

50mL Cyclonic	20-809-2951HE
---------------	---------------



#### Adaptor

Right Angle With Ball Joint	21-809-2761
Right Angle With Ball Joint (105mm long)	21-809-4237



#### HydraMist Simultaneous Cold Vapor/ Pneumatic Nebulization Spray Chamber

Thermo Duo 7600 Hydride Kit	KT-1156
Thermo Duo 6000/7200/7400 Hydride Kit	KT-1179



### Spray Chambers for HF

#### Tracey TFE

50mL Cyclonic	20-809-3469
---------------	-------------



**Torches**

**D-Torch** 30-808-2844

**Comprises:**

Base and Inner Tube 31-808-2932  
 Quartz Outer Tube 31-808-2840



**D-Torch Options:**

Ceramic Outer Tube 31-808-3834  
 Optic Fibre 170mm 31-808-2933  
 Optic Fibre 450mm 31-808-3117  
 Retaining Ring 31-808-2707  
 Injector Adaptor 31-808-2895  
 Injector Ferrule 31-808-2897



PTFE Coated  
 Viton O-rings (PKT 10) VT-007  
 Viton O-rings (PKT 10) V-026  
 O-ring kit for Thermo 6000/7000/PRO D-Torch 70-803-1921  
 O-ring and Seal kit for Thermo Torch & Windows 70-803-1550



**Ceramic Outer Tube and Optic Fibre for D-Torch** 31-808-3079

**Comprises:**

Ceramic Outer Tube 31-808-3834  
 Optic Fibre 170mm 31-808-2933  
 Optic Fibre 450mm 31-808-3117



**Quartz Torch**  
 EMT Design 31-808-2811



**Tapered Injectors for D-Torch & EMT Torch**

Quartz Injector 1.0mm 31-808-2833  
 Quartz Injector 1.5mm 31-808-2834

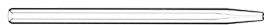

**Torches**

(continued)

**Capillary Injectors for D-Torch & EMT Torch**

Quartz Injector 2.0mm 31-808-2836  
 Quartz Injector 2.5mm 31-808-3246  
 Quartz Injector 3.0mm 31-808-3247  
 Alumina Injector 1.0mm 31-808-3279  
 Alumina Injector 2.0mm 31-808-2835  
 Sapphire Injector 2.0mm 31-808-2977



**Duo Periscope Window** 31-808-2677

O-ring for Periscope Window (PKT 10) 70-803-1603



**Quartz Window** 70-803-1116

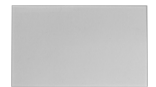

**Purged Optical Path (POP) Assembly** 70-803-1571

Window & O-Ring for Purged Optical Path (POP) 70-803-1892  
 O-ring for Thermo ICP Duo Periscope Window, (PKT 10) 70-803-1603



**RF Coils**

**RF Coil for 6000**

Silver, Teflon Coated 70-900-4002S  
 Gold, Teflon Coated 70-900-4002G



**RF Coil for 7000/6000 Mark II**

Silver, Teflon Coated 70-900-4005S  
 Gold, Teflon Coated 70-900-4005G



**RF Coil Installation Kit** 70-900-4002T



## Common Accessories

### Elegra Argon Humidifier

Elegra Argon Humidifier 70-803-1268



### Guardian In-Line Filters

Guardian DC in-line non-return gas filter 70-803-1942

Guardian in-line sample filter 70-803-1108

Eluo Adaptor for Inline Filter 70-803-1160



### Trident Internal Standard Kits

Trident CT Standard Kit 60-703-1179

Standard Kit for HF 60-808-1150

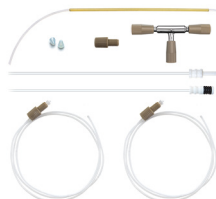

Magnifier Inspection Tool 70-803-1923



## Autosampler Probes (See page 20-21 for complete list of probes)

### For Cetac ASX-200/500/800 Series

Guardian Probe 0.75mm  
Probe Connecting Line (Red) 70-803-1803

Polyimide sheathed Autosampler  
Probe 0.5mm ID 60-808-1186L

PTFE Encapsulated Carbon  
Fibre Probe 0.5mm ID 70-803-0784

PTFE Encapsulated Carbon  
Fibre Probe 0.75mm ID 70-803-1443

PTFE Encapsulated Carbon  
Fibre Probe 1.0mm ID 70-803-0793





### Glass DC Nebulizers

#### SeaSpray

2mL/min uptake	A31-07-USS2
400µL/min uptake	A31-07-USS04

#### MicroMist

600µL/min uptake	A31-07-UM06
200µL/min uptake	A31-07-UM02
100µL/min uptake	A31-07-UM01
50µL/min uptake	A31-07-UM005



#### Conikal

2mL/min uptake	A31-07-UC2
1mL/min uptake	A31-07-UC1

#### Slurry

4mL/min uptake	A31-07-US6
----------------	------------

### DC Nebulizers for HF

#### DuraMist

1mL/min uptake	A31-07-DM1
400µL/min uptake	A31-07-DM04



#### OpalMist

2mL/min uptake	A31-07-PFA2
600µL/min uptake	A31-07-PFA06
200µL/min uptake	A31-07-PFA02
100µL/min uptake	A31-07-PFA01
50µL/min uptake	A31-07-PFA005



#### VeeSpray

0.6 - 3mL/min uptake	A31-07-CV6
----------------------	------------



### IsoMist XR

#### Programmable Temperature Cyclonic Spray Chamber

IsoMist XR Kit	KT-1021-XR
----------------	------------

#### Comprises:

Glass Twister Spray Chamber Assembly (LOL)	21-809-3185
PuraFlex Transfer Tube	21-809-3348
Glass Adaptor MB13-32	31-808-2790
Metal Ball Joint Clip	JC-13
UniFit Right Angle Connector (PKT 3)	GAZ-04-90



### Spray Chambers

#### Tracey

50mL Cyclonic	20-809-2665HE
---------------	---------------



#### Twister

50mL Cyclonic	20-809-2951HE
---------------	---------------



#### Straight Ball Joint Adaptor

21-809-2723
-------------



#### Sheath Gas Adaptor

31-808-3891
-------------



### Spray Chambers for HF

#### Tracey TFE

50mL Cyclonic	20-809-9198
---------------	-------------



## Torches

**D-Torch** 30-808-2877

**Comprises:**

- Base and Inner Tube 31-808-2932
- Quartz Outer Tube 31-808-2878
- Retaining Ring 31-808-2707
- Injector Adaptor 31-808-2895
- Injector Ferrule 31-808-2897



**D-Torch Options:**

- Ceramic Outer Tube 31-808-3836
- PTFE Coated
- Viton O-rings (PKT 10) VT-007
- Viton O-rings (PKT 10) V-026
- O-ring kit for Thermo 6000/7000/PRO D-Torch 70-803-1921
- O-ring and Seal kit for Thermo Torch & Windows 70-803-1550



**Quartz Torch**

EMT Design 31-808-2810



**Tapered Injectors for D-Torch & EMT Torch**

- Quartz Injector 1.0mm 31-808-2833
- Quartz Injector 1.5mm 31-808-2834



**Capillary Injectors for D-Torch & EMT Torch**

- Quartz Injector 2.0mm 31-808-2836
- Alumina Injector 1.0mm 31-808-3279
- Alumina Injector 2.0mm 31-808-2835
- Sapphire Injector 2.0mm 31-808-2977



## RF Coils

**RF Coil for 6000 Mark I**

- Silver, Teflon Coated 70-900-4002S
- Gold, Teflon Coated 70-900-4002G



**RF Coil for 7000/6000 Mark II**

- Silver, Teflon Coated 70-900-4005S
- Gold, Teflon Coated 70-900-4005G



**RF Coil Installation Kit** 70-900-4002T



## Common Accessories

**Elegra Argon Humidifier**

Elegra Argon Humidifier 70-803-1268



**Guardian In-Line Filters**

- Guardian DC in-line non-return gas filter 70-803-1942
- Guardian in-line sample filter 70-803-1108
- Eluo Adaptor for Inline Filter 70-803-1160



**Trident Internal Standard Kits**

- Trident CT Standard Kit 60-703-1179
- Standard Kit for HF 60-808-1150

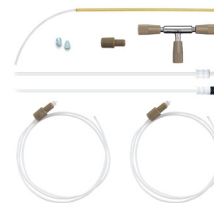

**Magnifier Inspection Tool** 70-803-1923



**Autosampler Probes** (See page 20-21 for complete list of probes)

**For Cetac ASX-200/500/800 Series**

- Guardian Probe 0.75mm
- Probe Connecting Line (Red) 70-803-1803
- Polyimide sheathed Autosampler Probe 0.5mm ID 60-808-1186L
- PTFE Encapsulated Carbon Fibre Probe 0.5mm ID 70-803-0784
- PTFE Encapsulated Carbon Fibre Probe 0.75mm ID 70-803-1443
- PTFE Encapsulated Carbon Fibre Probe 1.0mm ID 70-803-0793



## DC Nebulizer Gas Fitting Connectors

Agilent® 4100/4200	70-803-0969
Agilent® Vista/700-ES	70-803-0969
Agilent® 7700/7800/7900/8800/8900	70-803-1105
Agilent® 5100/5110/5800/5900	70-803-1105
Analytik Jena® ICP-MS	70-803-2002
Analytik Jena® ICP-OES	70-803-1105
Horiba® Jobin Yvon (All models)	70-803-1105
Leeman (All models)	70-803-0969
Nu Instruments ICP-MS	70-803-1858
Nu Instruments TOF-ICP-MS	70-803-2044
PerkinElmer® Optima and Avio	70-803-1070
PerkinElmer® Elan/NexION 300/350	70-803-1049
PerkinElmer® NexION 1000, 1100, 2000, 2200, 5000	70-803-1449
Radom MICAP – OES™1000	70-803-2054
Shimadzu® (All models)	70-803-1311
Spectro™ (All models)	70-803-1070
Standard BioTools™ Helios	70-803-1070
Thermo® PRO, 6000/7000, Q/RQ/TQ, X-Series & Neoma	70-803-1105
Thermo® Neptune	70-803-0969
Elegra to DC Nebulizer	70-803-1278
ICP Gas Inlet Fitting Type 11/61	70-803-1934
ICP Gas Inlet Fitting Type 13/31	70-803-1504
ICP Gas Inlet Fitting Type 21	70-803-1069
ICP Gas Inlet Fitting Type 22	70-803-2110
ICP Gas Inlet Fitting Type 23	70-803-2111
ICP Gas Inlet Fitting Type 41	70-803-1562
ICP Gas Inlet Fitting Type 51	70-803-1857
ICP Gas Inlet Fitting Type 52	70-803-2048
ICP Gas Inlet Fitting Type 70	70-803-2084

## Nexus Universal Nebulizer Connection Kit

The Nexus Universal Nebulizer Connection Kit is a quick and easy way to ensure a leak tight connection of 1/16" or 1.3mm OD sample capillary to a Glass Expansion concentric nebulizer such as the SeaSpray, Conikal, MicroMist, DuraMist or OpalMist nebulizers. If you need to make a leak tight seal to your nebulizer - whether it is to a HPLC for speciation or a high throughput switching valve use this kit.

Nexus Universal Nebulizer Connection Kit (Suitable for DuraMist, OpalMist and glass concentric nebulizers)	FT-16-8-X
Nexus Universal Nebulizer Connection Kit (Suitable for all glass concentric nebulizers)	FT-16-8
Tefzel Ferrule 1/8 inch (PKT 10)	70-803-1513
Tefzel Ferrule 1/16 inch (PKT 10)	70-803-1315

## EzyLok Kit for Nebulizer Gas Side Arm

EzyLok Kit	EL-1
<b>Comprises:</b>	
EzyLok Connector for 4mm Tubing	QSM-4
EzyLok 6mm Hose Adaptor	70-808-0735
Hose Clip, 6mm	SNP-1

## Tubing Connector

1.3mm to 1/16 inch	FT-16-1.3
1/16 inch to 1/16 inch	FT-16-1.6

## Sample Tube Connectors (PKT 10)

	UniFit P/N	EzyFit P/N
0.25mm ID x 1.27mm OD x 700mm long	NFT-025	EZT-025
0.25mm ID x 1.27mm OD x 2000mm long	NFT2-025	EZT2-025
0.75mm ID x 1.27mm OD x 700mm long	NFT-075	EZT-075
0.75mm ID x 1.27mm OD x 1500mm long	NFTS-075	EZTS-075
0.25mm ID x 1/16" OD x 700mm long	NFT-16-25	EZT-16-25
0.25mm ID x 1/16" OD x 1500mm long	NFTS-16-25	EZTS-16-25
0.75mm ID x 1/16" OD x 700mm long	NFT-16-75	EZT-16-75
0.75mm ID x 1/16" OD x 1500mm long	NFTS-16-75	EZTS-16-75

## Sample Tubing

0.25mm ID x 1.27mm OD x 10m long	STT-025
0.50mm ID x 1.27mm OD x 10m long	STT-050
0.75mm ID x 1.27mm OD x 10m long	STT-075
0.25mm ID x 1/16" OD x 10m long	STT-16-25
0.50mm ID x 1/16" OD x 10m long	STT-16-50
0.75mm ID x 1/16" OD x 10m long	STT-16-75
1.0mm ID x 1/16" OD x 10m long	STT-16-100
0.3mm ID x 0.75mm OD x 10m long	STT-0703
0.13mm ID x 1.27mm OD x 10m long	PFT-013
0.18mm ID x 1.27mm OD x 10m long	PFT-018
0.07mm ID x 1/16" OD x 10m long	PFT-16-07
0.13mm ID x 1/16" OD x 10m long	PFT-16-13
0.18mm ID x 1/16" OD x 10m long	PFT-16-18
1/8" ID x 1/4" OD x 1m long	1/4PFA-HW
Tefzel 0.5mm ID x 1.3mm OD x 10m long	TFE-050

## Other Tubing

Reagent tube 1.6mm OD x 1.0mm ID x 1400mm long with PTFE Sinkers (PKT. 3)	70-803-0752
Tygon Tubing 1/4 inch x 1m	1921-1M

## Helix & Helix CT Spray Chambers

### Helix CT:

Helix CT Locking Screw with Seal	70-803-1439
Helix CT Locking Screw with Seal for MiraMist	70-803-1470
Helix CT Seal (PKT 4)	70-803-1456

### Helix:

Helix Locking Screw	70-100-0152
Helix Seal (PKT 4)	70-100-0237

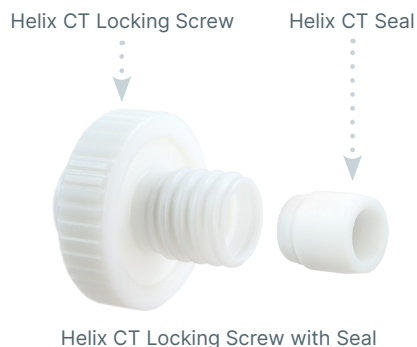

## O-Rings Spray Chambers

O-ring set for Large Adaptor (Tracey, Twister)	70-808-0501
O-ring set for Small Adaptor (Cinnabar, Twinnabar)	21-808-0818
Teflon coated Viton O-Rings for spray chamber, nebulizer seal (PKT 10)	VT-009
Teflon coated Viton O-Rings for spray chamber, 16mm large adaptor seal (PKT 10)	VT-10/2
Silicon o-rings for spray chamber, nebulizer seal (PKT 10)	S-009

## GazFit Connectors for Torches

GazFit Connectors (PKT 2), for 8mm OD arm	GAZ-08
GazFit Connectors (PKT 4), for 6mm OD torch side arms	GAZ-06
GazFit Connectors (PKT 4), 2 for 6mm OD torch side arms, 2 for 4mm OD torch side arms	GAZ-0604
GazFit Connectors (PKT 4), for 5mm OD torch side arms	GAZ-05
GazFit Connectors (PKT 4), for 4mm OD torch side arms	GAZ-04

GazFit connectors are only suitable for torches with tolerances of no more than +/- 0.15mm on the diameter of the side arms.

All Glass Expansion torches meet this specification.



## Clips & Connectors for Spray Chambers

Metal Ball Joint Clip (to connect spray chamber and torch)	JC-13
Metal Ball Joint Clip (to connect spray chamber and torch with S19)	JC-19
Nickel Joint Clip B14 (to connect spray chamber and drain adaptors)	KCM-14
Nickel Joint Clip KCM29 (to connect spray chamber and drain adaptors)	KCM-29
UniFit Connector with sample tube, 0.75mm ID x 1/16" OD x 700mm long (PKT 3)	UFT-16-75
UniFit Connector with sample tube, 0.75mm ID x 1.3mm OD x 700mm long (PKT 3)	UFT-075
UniFit Connector with sample tube, 0.86mm ID x 2mm OD x 480mm long (PKT 3)	UFT-2-86
UniFit Connector with sample tube, 0.86mm ID x 2mm OD x 700mm long (PKT 3)	UFT-2-700
Connector Assembly for Agilent® Scott Spray Chamber	70-803-1476
HydraMist Drain (PKT 4)	GAZ-08-4



## O-Rings for Torches

Viton O-Rings for demountable torch ball joint connectors (PKT 10)	70-V-011
--	----------

## PVC Peristaltic Pump Tubing

All tubes made from Tygon R3603/R3607 or equivalent. Supplied in packs of 12 tubes.

### Special Properties:

Inexpensive all-round tubing for general laboratory applications.

### Advantages:

- Resistant to almost all inorganic materials.
- Does not age.
- Low gas permeability.
- Smooth inner surface.

### Limitations:

- Potential leaching of plasticizers.

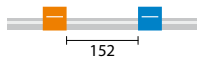

**PVC, 2 Bridged, 152mm**  
(152mm between tags)

Tag Colours	ID (mm)	P/N
orange/black	0.13	0.13-OBLK
orange/red	0.19	0.19-OR
orange/blue	0.25	0.25-OB
orange/green	0.38	0.38-OG
green/yellow	0.44	0.44-GY
orange/yellow	0.51	0.51-OY
white/yellow	0.57	0.57-WY
orange/white	0.64	0.64-OW
black/black	0.76	0.76-BLK
orange/orange	0.89	0.89-ORG
white/black	0.95	0.95-WBLK
white/white	1.02	1.02-WHT
white/red	1.09	1.09-WR
red/red	1.14	1.14-RED
red/grey	1.22	1.22-RGRY
grey/grey	1.30	1.30-GRY
yellow/yellow	1.42	1.42-YLW
yellow/blue	1.52	1.52-YB
blue/blue	1.65	1.65-BLU
blue/green	1.75	1.75-BG
green/green	1.85	1.85-GRN
purple/purple	2.06	2.06-PUR
purple/black	2.29	2.29-PBLK
purple/orange	2.54	2.54-PO
purple/white	2.79	2.79-PW
black/white	3.17	3.17-BLKW

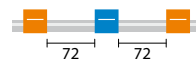

**PVC, 3 Bridged, 72mm**  
(72mm between tags)

Tag Colours	ID (mm)	P/N
orange/black	0.13	0.13-OBLK3B
orange/red	0.19	0.19-OR3B
orange/blue	0.25	0.25-OB3B
orange/green	0.38	0.38-OG3B
green/yellow	0.44	0.44-GY3B
orange/yellow	0.51	0.51-OY3B
white/yellow	0.57	0.57-WY3B
orange/white	0.64	0.64-OW3B
black/black	0.76	0.76-BLK3B
orange/orange	0.89	0.89-ORG3B
white/black	0.95	0.95-WBLK3B
white/white	1.02	1.02-WHT3B
white/red	1.09	1.09-WR3B
red/red	1.14	1.14-RED3B
red/grey	1.22	1.22-RGRY3B
grey/grey	1.30	1.30-GRY3B
yellow/yellow	1.42	1.42-YLW3B
yellow/blue	1.52	1.52-YB3B
blue/blue	1.65	1.65-BLU3B
green/green	1.85	1.85-GRN3B
purple/purple	2.06	2.06-PUR3B
purple/black	2.29	2.29-PBLK3B
purple/orange	2.54	2.54-PO3B
purple/white	2.79	2.79-PW3B
black/white	3.17	3.17-BLKW3B

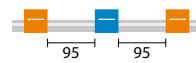

**PVC, 3 Bridged, 95mm**  
(95mm between tags)

Tag Colours	ID (mm)	P/N
orange/blue	0.25	0.25-OB3B-95
orange/green	0.38	0.38-OG3B-95
orange/yellow	0.51	0.51-OY3B-95
orange/white	0.64	0.64-OW3B-95
black/black	0.76	0.76-BLK3B-95
orange/orange	0.89	0.89-ORG3B-95
white/white	1.02	1.02-WHT3B-95
grey/grey	1.30	1.30-GRY3B-95
yellow/blue	1.52	1.52-YB3B-95
green/green	1.85	1.85-GRN3B-95
purple/white	2.79	2.79-PW3B-95

## Solva Peristaltic Pump Tubing

All tubes made from Tygon 4040 or equivalent. Supplied in packs of 12 tubes.

### Special Properties:

Special tubing for hydrocarbons, petroleum products and distillates.

### Advantages:

- Specially formulated to transport hydrocarbons, petroleum products and distillates.
- Ideal for gasoline, kerosene, heating oils, cutting liquids and coolants based on glycols.
- Low gas permeability.

### Limitations:

- Not recommended for strong acids and alkalies, foodstuffs, beverages and medicines.
- Potential leaching of plasticizers.

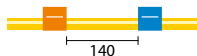

**Solva, 2 Bridged, 140mm**  
(140mm between tags)

Tag Colours	ID (mm)	P/N
orange/blue	0.25	0.25-OB-SF
orange/green	0.38	0.38-OG-SF
orange/yellow	0.51	0.51-OY-SF
orange/white	0.64	0.64-OW-SF
black/black	0.76	0.76-BLK-SF
orange/orange	0.89	0.89-ORG-SF
white/white	1.02	1.02-WHT-SF
red/red	1.14	1.14-RED-SF
grey/grey	1.30	1.30-GRY-SF
yellow/yellow	1.42	1.42-YLW-SF
yellow/blue	1.52	1.52-YB-SF
blue/blue	1.65	1.65-BLU-SF
green/green	1.85	1.85-GRN-SF
purple/purple	2.06	2.06-PUR-SF
purple/black	2.29	2.29-PBLK-SF
purple/orange	2.54	2.54-PO-SF
purple/white	2.79	2.79-PW-SF

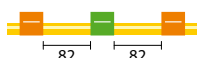

**Solva, 3 Bridged, 82mm**  
(82mm between tags)

Tag Colours	ID (mm)	P/N
orange/green	0.38	0.38-OG3B-SF
black/black	0.76	0.76-BLK3B-SF
orange/orange	0.89	0.89-ORG3B-SF
white/white	1.02	1.02-WHT3B-SF
red/red	1.14	1.14-RED3B-SF
grey/grey	1.30	1.30-GRY3B-SF

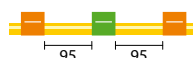

**Solva, 3 Bridged, 95mm**  
(95mm between tags)

Tag Colours	ID (mm)	P/N
orange/green	0.38	0.38-OG3B-95-SF
orange/yellow	0.51	0.51-OY3B-95-SF
black/black	0.76	0.76-BLK3B-95-SF
orange/orange	0.89	0.89-ORG3B-95-SF
white/white	1.02	1.02-WHT3B-95-SF
yellow/blue	1.52	1.52-YB3B-95-SF

## Viton® Peristaltic Pump Tubing

All tubes made from Fluran HC F-5500-A or equivalent.

### Special Properties:

Special tubing for concentrated acids and corrosive solvents.

### Advantages:

- High chemical resistance.
- Low gas permeability.
- Wide temperature range.

### Limitations:

- Limited service life.

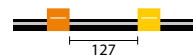

**Viton®, 2 Bridged, 127mm**  
(127mm between tags)

Tag Colours	ID (mm)	P/N
orange/yellow	0.51	VS0.51-OY
orange/white	0.64	VS0.64-OW
black/black	0.76	VS0.76-BLK
orange/orange	0.89	VS0.89-ORG
white/white	1.02	VS1.02-WHT
red/red	1.14	VS1.14-RED
grey/grey	1.30	VS1.30-GRY
yellow/yellow	1.42	VS1.42-YLW
yellow/blue	1.52	VS1.52-YB
blue/blue	1.65	VS1.65-BLU
green/green	1.85	VS1.85-GRN
purple/purple	2.06	VS2.06-PUR
purple/black	2.29	VS2.29-PBLK
purple/orange	2.54	VS2.54-PO
purple/white	2.79	VS2.79-PW

Supplied in packs of 12 tubes

## Tygon® MH Peristaltic Pump Tubing

All tubes made from Tygon MHSL 2001.

### Special Properties:

- Environmental-friendly tubing especially designed for solvents.
- Suitable for MIBK.

### Advantages:

- High chemical resistance.
- Low gas permeability.
- Wide temperature range.

### Limitations:

Limited service life.



**Tygon® MH , 2 Bridged, 152mm**  
(152mm between tags)

Tag Colours	ID (mm)	P/N
	0.38	0.38-ORG-MH
	0.64	0.64-OW-MH
	1.02	1.02-WHT-MH
	1.52	1.52-YB-MH
	2.06	2.06-PUR-MH
	2.79	2.79-PW-MH

Supplied in packs of 6 tubes

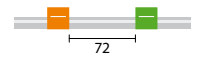

**Tygon® MH , 2 Bridged, 72mm**  
(72mm between tags)

Tag Colours	ID (mm)	P/N
	0.38	0.38-ORG-MH3
	0.64	0.64-OW-MH3
	1.02	1.02-WHT-MH3
	1.52	1.52-YB-MH3
	2.06	2.06-PUR-MH3
	2.79	2.79-PW-MH3

Supplied in packs of 6 tubes

It can be quite difficult to insert the sample tubing into the peristaltic pump tubes. This is particularly so for pump tubing with a small ID. To facilitate this connection, Glass Expansion supplies Contour flared-end pump tubing. The flared end of this pump tubing allows the larger capillary tubing to be inserted into the smaller pump tubing.

Any of the pump tubing that we normally supply can be supplied with flared end. Simply add “-F” to the end of the part number (eg. 0.38-OG-F). The flared-end tubing is supplied in packs of 6.

## Contour Flared-end PVC Peristaltic Pump Tubing

All tubes made from Tygon R3603/R3607 or equivalent. Supplied in packs of 6 tubes.

### Special Properties:

Inexpensive all-round tubing for general laboratory applications.

### Advantages:

- Transparent.
- Resistant to almost all inorganic materials.
- Does not age.
- Low gas permeability.
- Smooth inner surface.

### Limitations:

- Potential leaching of plasticizers.

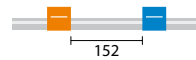

**PVC, 2 Bridged, 152mm**  
(152mm between tags)

Tag Colours	ID (mm)	P/N
	0.13	0.13-OBLK-F
	0.19	0.19-OR-F
	0.25	0.25-OB-F
	0.38	0.38-OG-F
	0.44	0.44-GY-F
	0.51	0.51-OY-F
	0.57	0.57-WY-F
	0.64	0.64-OW-F
	0.76	0.76-BLK-F
	0.89	0.89-ORG-F
	0.95	0.95-WBLK-F
	1.02	1.02-WHT-F
	1.09	1.09-WR-F
	1.14	1.14-RED-F
	1.22	1.22-RGRY-F
	1.30	1.30-GRY-F
	1.42	1.42-YLW-F
	1.52	1.52-YB-F

# Contour Flared-end Peristaltic Pump Tubing



**PVC, 2 Bridged, 152mm**  
(152mm between tags)

(continued)

Tag Colours	ID (mm)	P/N
	1.65	1.65-BLU-F
	1.75	1.75-BG-F
	1.85	1.85-GRN-F
	2.06	2.06-PUR-F
	2.29	2.29-PBLK-F
	2.54	2.54-PO-F
	2.79	2.79-PW-F
	3.17	3.17-BLKW-F



**PVC, 2 Bridged, 72mm**  
(72mm between tags)

Tag Colours	ID (mm)	P/N
	0.19	0.19-OR-F-S
	0.25	0.25-OB-F-S
	0.76	0.76-BLK-F-S
	0.89	0.89-ORG-F-S
	1.02	1.02-WHT-F-S



**PVC, 2 Bridged, 95mm**  
(95mm between tags)

Tag Colours	ID (mm)	P/N
	0.19	0.19-OR-95-F-S
	0.25	0.25-OB-95-F-S
	0.38	0.38-OG-95-F-S
	0.44	0.44-GY-95-F-S
	0.51	0.51-OY-95-F-S
	0.64	0.64-OW-95-F-S
	0.76	0.76-BLK-95-F-S
	1.30	1.30-GRY-95-F-S

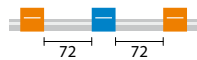

**PVC, 3 Bridged, 72mm**  
(72mm between tags)

Tag Colours	ID (mm)	P/N
	0.13	0.13-OBLK3B-F
	0.19	0.19-OR3B-F
	0.25	0.25-OB3B-F
	0.38	0.38-OG3B-F
	0.44	0.44-GY3B-F
	0.51	0.51-OY3B-F
	0.57	0.57-WY3B-F
	0.64	0.64-OW3B-F
	0.76	0.76-BLK3B-F
	0.89	0.89-ORG3B-F
	0.95	0.95-WBLK3B-F
	1.02	1.02-WHT3B-F
	1.09	1.09-WR3B-F
	1.14	1.14-RED3B-F
	1.22	1.22-RGRY3B-F
	1.30	1.30-GRY3B-F
	1.42	1.42-YLW3B-F
	1.52	1.52-YB3B-F
	1.65	1.65-BLU3B-F
	1.85	1.85-GRN3B-F
	2.06	2.06-PUR3B-F
	2.29	2.29-PBLK3B-F
	2.54	2.54-PO3B-F
	2.79	2.79-PW3B-F
	3.17	3.17-BLKW3B-F

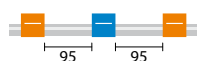

**PVC, 3 Bridged, 95mm**  
(95mm between tags)

Tag Colours	ID (mm)	P/N
	0.25	0.25-OB3B-95-F
	0.38	0.38-OG3B-95-F
	0.51	0.51-OY3B-95-F
	0.76	0.76-BLK3B-95-F
	0.89	0.89-ORG3B-95-F
	1.02	1.02-WHT3B-95-F
	1.30	1.30-GRY3B-95-F
	1.52	1.52-YB3B-95-F
	1.85	1.85-GRN3B-95-F
	2.79	2.79-PW3B-95-F



## Contour Flared-end Solva Peristaltic Pump Tubing

All tubes made from Tygon 4040 or equivalent. Supplied in packs of 6 tubes.

### Special Properties:

Special tubing for hydrocarbons, petroleum products and distillates.

### Advantages:

- Specially formulated to transport hydrocarbons, petroleum products and distillates.
- Ideal for gasoline, kerosene, heating oils, cutting liquids and coolants based on glycols.
- Low gas permeability.

### Limitations:

- Not recommended for strong acids and alkalies, foodstuffs, beverages and medicines.
- Potential leaching of plasticizers.

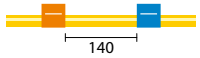

**Solva, 2 Bridged, 140mm**  
(140mm between tags)

Tag Colours	ID (mm)	P/N
orange/blue	0.25	0.25-OB-SF-F
orange/green	0.38	0.38-OG-SF-F
orange/yellow	0.51	0.51-OY-SF-F
orange/white	0.64	0.64-OW-SF-F
black/black	0.76	0.76-BLK-SF-F
orange/orange	0.89	0.89-ORG-SF-F
white/white	1.02	1.02-WHT-SF-F
red/red	1.14	1.14-RED-SF-F
grey/grey	1.30	1.30-GRY-SF-F
yellow/yellow	1.42	1.42-YLW-SF-F
yellow/blue	1.52	1.52-YB-SF-F
blue/blue	1.65	1.65-BLU-SF-F
green/green	1.85	1.85-GRN-SF-F
purple/purple	2.06	2.06-PUR-SF-F
purple/black	2.29	2.29-PBLK-SF-F
purple/orange	2.54	2.54-PO-SF-F
purple/white	2.79	2.79-PW-SF-F

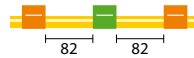

**Solva, 3 Bridged, 82mm**  
(82mm between tags)

Tag Colours	ID (mm)	P/N
orange/green	0.38	0.38-OG3B-SF-F
black/black	0.76	0.76-BLK3B-SF-F
orange/orange	0.89	0.89-ORG3B-SF-F
red/red	1.14	1.14-RED3B-SF-F
grey/grey	1.30	1.30-GRY3B-SF-F

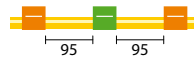

**Solva, 3 Bridged, 95mm**  
(95mm between tags)

Tag Colours	ID (mm)	P/N
orange/green	0.38	0.38-OG3B-95-SF-F
orange/yellow	0.51	0.51-OY3B-95-SF-F
black/black	0.76	0.76-BLK3B-95-SF-F
orange/orange	0.89	0.89-ORG3B-95-SF-F
white/white	1.02	1.02-WHT3B-95-SF-F
yellow/blue	1.52	1.52-YB3B-95-SF-F

## Contour Flared-end Viton® Peristaltic Pump Tubing

All tubes made from Fluran HC F-5500-A or equivalent.

### Special Properties:

Special tubing for concentrated acids and corrosive solvents.

### Advantages:

- High chemical resistance.
- Low gas permeability.
- Wide temperature range.

### Limitations:

Limited service life.



**Viton®, 2 Bridged, 127mm**  
(127mm between tags)

Tag Colours	ID (mm)	P/N
	0.51	VS0.51-OY-F
	0.64	VS0.64-OW-F
	0.76	VS0.76-BLK-F
	0.89	VS0.89-ORG-F
	1.02	VS1.02-WHT-F
	1.14	VS1.14-RED-F
	1.30	VS1.30-GRY-F
	1.42	VS1.42-YLW-F
	1.52	VS1.52-YB-F
	1.65	VS1.65-BLU-F
	1.85	VS1.85-GRN-F
	2.06	VS2.06-PUR-F
	2.29	VS2.29-PBLK-F
	2.54	VS2.54-PO-F
	2.79	VS2.79-PW-F

Supplied in packs of 6 tubes

## Contour Flared-end Tygon® MH Peristaltic Pump Tubing

All tubes made from Tygon MHSL 2001.

### Special Properties

- Environmental-friendly tubing especially designed for solvents.
- Suitable for MIBK.

### Advantages:

- High chemical resistance.
- Low gas permeability.
- Wide temperature range.

### Limitations:

Limited service life.

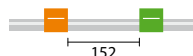

**Tygon® MH, 2 Bridged, 152mm**  
(152mm between tags)

Tag Colours	ID (mm)	P/N
	0.38	0.38-ORG-MH-F
	0.64	0.64-OW-MH-F
	1.02	1.02-WHT-MH-F
	1.52	1.52-YB-MH-F
	2.06	2.06-PUR-MH-F
	2.79	2.79-PW-MH-F

Supplied in packs of 6 tubes

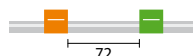

**Tygon® MH, 2 Bridged, 72mm**  
(72mm between tags)

Tag Colours	ID (mm)	P/N
	0.38	0.38-ORG-MH3-F
	0.64	0.64-OW-MH3-F
	1.02	1.02-WHT-MH3-F
	1.52	1.52-YB-MH3-F
	2.06	2.06-PUR-MH3-F
	2.79	2.79-PW-MH3-F

Supplied in packs of 6 tubes



Please contact:



**AHF analysentechnik AG**

Kohlplattenweg 18 · 72074 Tübingen · GERMANY

Tel.: +49 7071 53 952-00 · Fax: -99

info@ahf.de · www.ahf.de



### **Asia Pacific**

6 Central Boulevard  
Port Melbourne  
Vic 3207, Australia

**Telephone:** +61 3 9320 1111

**Email:** enquiries@geicp.com

### **Europe**

Friedenbachstrasse 9  
35781 Weilburg  
Germany

**Telephone:** +49 6471 3778517

**Email:** gegmbh@geicp.com

### **Americas**

31 Jonathan Bourne Drive, Unit 7  
Pocasset, MA 02559, USA

**Toll Free Phone:** 800 208 0097

**Telephone:** 508 563 1800

**Facsimile:** 508 563 1802

**Email:** geusa@geicp.com

**August 2024**